

icom

INSTRUCTION MANUAL

HF AUTOMATIC ANTENNA TUNER

**AT-130**  
**AT-130E**



Icom Inc.

## IMPORTANT

**READ ALL INSTRUCTIONS** carefully and completely before using the AT-130 and AT-130E.

**SAVE THIS INSTRUCTION MANUAL.** This instruction manual contains important safety and installation instructions.

## PRECAUTIONS

**DANGER HIGH VOLTAGE! NEVER** touch the antenna terminal, ground terminal, antenna or counterpoise while transmitting. Place the AT-130 or AT-130E, antenna and counterpoise in positions where no one touches them.

**NEVER** use without a ground connection.

**NEVER** transmit during internal adjustment to prevent electric shock.

**USE** the ground terminal for ground connection. The mounting plate is not connected internally.

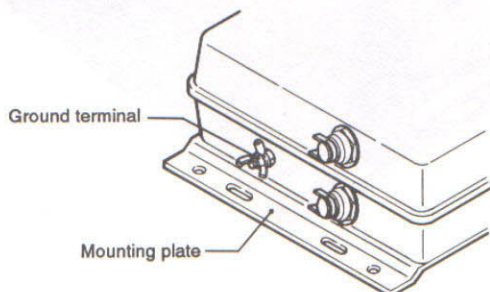

**DO NOT** operate your HF marine transceiver without running the boat's engine.

**AVOID** using the AT-130 or AT-130E in areas where the temperature is below  $-30^{\circ}\text{C}$  or above  $+60^{\circ}\text{C}$ .

## EXPLICIT DEFINITIONS

The explicit definitions in this instruction manual.

Word	Definition
<b>WARNING</b>	Personal injury, fire hazard or electric shock may occur.
<b>CAUTION</b>	Equipment damage may occur.
<b>NOTE</b>	If disregarded, inconvenience only. No personal injury, fire hazard or electric shock will occur.

## FOREWORD

Thank you for purchasing the AT-130 or AT-130E HF AUTOMATIC ANTENNA TUNER.

The AT-130 and AT-130E are designed, primarily for use with Icom HF transceivers. To meet with European regulations, the AT-130E includes an extra emergency tuner circuit for 2182 kHz operation.

Refer to your HF transceiver instruction manual for operation. If you have any questions, contact your nearest authorized Icom Dealer or Service Center.

## UNPACKING

The following parts are supplied with the AT-130/E.

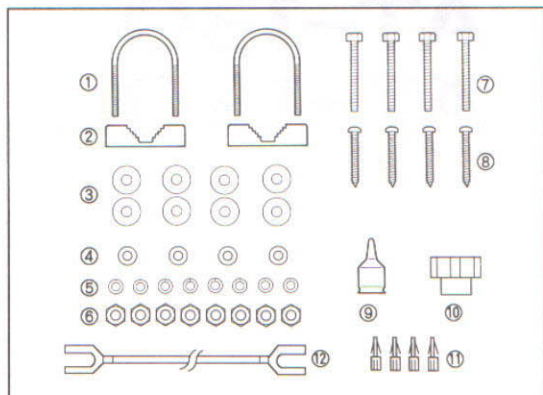

### Qty.

① U-bolts	2
② U-bolt plates	2
③ Flat washers (M6 large)	8
④ Flat washers (M6 small)	4
⑤ Spring washers (M6)	8
⑥ Nuts (M6)	8
⑦ Hex head bolts (M6 x 50)	4
⑧ Self-tapping screws (A0 6 x 30)	4
⑨ Weatherproof cap	1
⑩ 4-pin connector	1
⑪ Connector pins	4
⑫ Ground cable (OPC-412)	1

## MISCELLANEOUS ITEMS

The following parts are required for installation, but are not supplied with the AT-130 or AT-130E.

- ① AWG 14 x 4-conductor shielded cable  
\*Icom offers an optional OPC-420 CONTROL CABLE.  
Length: 10 m; 32.8 feet
- ② 50  $\Omega$  coaxial cable
- ③ PL-259 connectors

---

## TABLE OF CONTENTS

---

IMPORTANT .....	i
PRECAUTIONS .....	i
EXPLICIT DEFINITIONS .....	i
FOREWORD .....	i
UNPACKING .....	i
MISCELLANEOUS ITEMS .....	i
TABLE OF CONTENTS .....	ii
FEATURES .....	ii
<b>1 ANTENNA SYSTEM.....</b>	<b>1-2</b>
■ Antenna for ship.....	1
■ Antenna for land operation .....	1
■ Coaxial cable .....	2
■ Ground and counterpoise .....	2
<b>2 INSTALLATIONS.....</b>	<b>3-4</b>
■ Installation outline .....	3
■ Cable installation .....	3
■ PL-259 connector .....	3
■ Control cable .....	4
■ Cable connections .....	4
■ Mounting .....	4
<b>3 INTERNAL SETTINGS .....</b>	<b>5-6</b>
■ Before internal settings .....	5
■ Mode switch .....	5
■ Preset tuning .....	5
■ Emergency tuning (AT-130E) .....	6
<b>4 CONTROL CABLE SIGNALS .....</b>	<b>7</b>
■ Terminal information .....	7
■ Transceiver switch .....	7
<b>5 INSIDE VIEW AND SPECIFICATIONS .....</b>	<b>8</b>
■ Inside view.....	8
■ Specifications .....	8

---

## FEATURES

---

### Matches all bands

The AT-130/E matches any frequency on every HF marine band. For example, the tuner matches a 7 m; 23.0 feet long-wire antenna across 1.6–30 MHz.

### Full automatic tuning

Just push the [TUNE] switch on a transceiver, the AT-130/E adjusts immediately to the minimum SWR in any frequency on any HF marine band.

### HF operation on any size ship

The AT-130/E allows you HF operation where antenna element length is restricted due to space.

### Weather resistant

The AT-130/E is housed in a durable, completely weather-resistant acrylic case with a rubber gasket. The antenna tuner can be conveniently installed both on the deck or in the cabin near the antenna element.

### Simple installation

Installation is simple. Just connect the control and antenna cables and short-time internal settings. After installation, you never need to open the cover for maintenance.

### Preset tuning function

This function provides super fast tuning on your most-used frequency.

### 45 memories for shorter tuning time

To decrease the tune-up time, the AT-130/E automatically stores the matching conditions for up to 45 frequencies. Retuning for a memorized frequency takes only approx. 1 sec.

### Super capacitor for memory backup

Even if the AT-130/E is not used for approx. 1 week, the built-in super capacitor backs up the 45 memory contents.

### Low power tune up

The AT-130/E emits low output power during tuning. This feature reduces the possibility of causing interference to other stations.

### Emergency tuner circuit (AT-130E)

To meet with European regulations, the Europe version AT-130E includes an emergency tuner circuit for 2182 kHz operation. If any signal from the control cable indicates an abnormal condition, this circuit is automatically selected.

# 1 ANTENNA SYSTEM

## Antenna for ship

### Required antenna element length

Required antenna element length to achieve full performance varies according to the lowest frequency:

The lowest frequency	Required antenna element length
1.6 MHz band	7 m; 23.0 feet or longer
4 MHz band	3 m; 9.8 feet or longer

The longer the antenna element, the better the antenna efficiency.

### Undesireable antenna element lengths

**AVOID** multiples of  $1/2 \lambda$  (half wavelength) for antenna element lengths, since tuning becomes difficult.

L : Antenna element length to be avoided [m]

f : Operating frequency [MHz]

n : Natural number (n = 1, 2, 3, ...)

$$L = \frac{300}{f} \times \frac{1}{2} \times n$$

#### [Example]

At an operating frequency of 16 MHz, avoid the following antenna element lengths:

$$L = \frac{300}{16} \times \frac{1}{2} \times n \approx 9.4, 18.8, \dots$$

$$1 \text{ m} \approx 39 \text{ inches}$$

For example, if 15 m is selected for an antenna element length, you have no problem in 1.6–25 MHz marine bands.

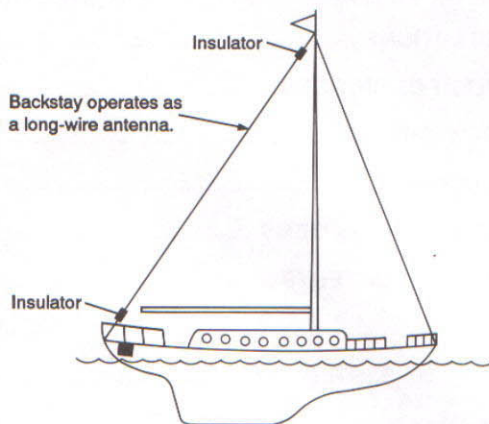

**NOTE:** Keep antennas as far away from other objects as possible, especially metal objects.

## Antenna for land operation

In some countries, HF transceivers can be used for land mobile operation. Ask your Icom Dealer for details, since the radio law varies according to countries.

For land mobile operation on 4 MHz and above, an optional AH-2b ANTENNA ELEMENT is available. The AH-2b includes a sturdy tow hook mount system for holding a 2.5 m; 8.2 feet stainless steel antenna element plus all the necessary hardware.

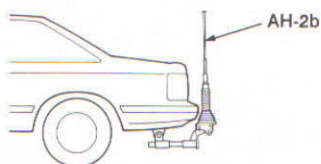

Refer to the AH-2b instruction manual for the AH-2b and AT-130/E installation to your vehicle. Ask your Icom Dealer for details.

Connect a suitable antenna element for a coastal station. To achieve full performance, refer to "Required antenna element length" above.

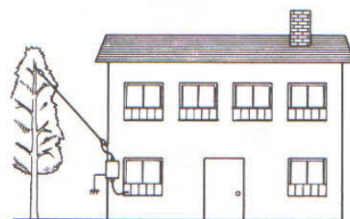

## Coaxial cable

Insulate the lead-in cable of the AT-130/E antenna terminal and antenna element from other metal objects.

To prevent interference, keep cables as far as possible from an antenna, electric pump and other electronic equipment.

To prevent erroneous indications, keep cables as far away as possible from the flux gate compass.

Use suitable noise filters for alternators, fluorescent lights, etc. Ask your Icom Dealer for details.

## Ground and counterpoise

### Why ship's ground is required

The AT-130/E's ground terminal **MUST** be connected to your ship's ground. Grounding prevents electric shocks, interference to other equipment and other problems. Grounding also ensures effective signal transmission.

**DANGER! NEVER** connect the ground terminal to the following points. These connections may cause an explosion or electric shocks:

- Gas or electrical pipe
- Fuel tank
- Oil-catch pan

**BE CAREFUL.** The mounting plate is **NOT** connected to the AT-130/E's internal ground. Non-through mast is **NOT** electrically connected to sea water.

### Ideal ground points

One of following points is ideal:

- Ship's ground terminal
- External ground plate
- External copper screen

### Good ground points

If electrically connected to sea water, one of the following points is usable:

- Stainless steel tuna tower
- Stainless steel stanchion
- Through mast
- Through hull
- Metal water tank

### Undesireable ground points

**AVOID** the following points, if possible. These connections may cause noise or electrolysis:

- Engine block
- Keel bolt

### Electrolysis

All ground cables from the AT-130/E, HF transceiver, etc. on your ship should be connected to only 1 ship's ground.

**AVOID** connection to 2 or more points. Voltage differences between 2 or more ship's grounds may cause electrolysis.

**AVOID** connections between dissimilar metals where an electric current is present. These connections may cause electrolysis.

### Counterpoise

If your ship is made of FRP, etc. and a good ship's ground is not available, connect a counterpoise.

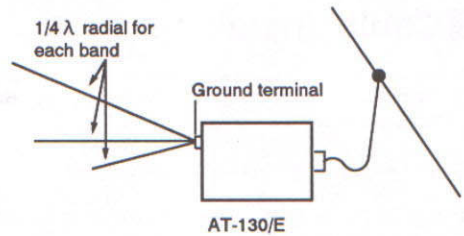

1/4 λ (quarter wavelength) radial for each band is suitable for a counterpoise. Install the counterpoise directly below the AT-130/E's ground terminal. Insulate the ends of each radial from other metal objects. Layout the radials horizontally and as straight as possible.

L : Counterpoise length for the operating frequency [m]  
f : Operating frequency [MHz]

$$L = \frac{300}{f} \times \frac{1}{4}$$

### [Example]

At an operating frequency of 16 MHz, use a counterpoise with the following length:

$$L = \frac{300}{16} \times \frac{1}{4} \approx 4.7 \text{ [m]}$$

1 m ≈ 39 inches

### Ground cable

For the best results, use the heaviest gauge wire or metal strap available. Make the distance between the AT-130/E's ground terminal and ship's ground as short as possible.

Supplied ground cable is usable for ground connection to a through mast. Confirm that the through mast is electrically connected to sea water.

# 2 INSTALLATIONS

## Installation outline

- 1) Remove the top cover.
- 2) Install a control cable and coaxial cable.
  - Refer to "Cable installation" below.
- 3) Connect and solder the PL-259 connector to the coaxial cable.
  - Refer to "PL-259 connector" below.
- 4) Connect the control cable to the AT-130/E.
  - Refer to p. 4 "Cable connection."
- 5) Mount the AT-130/E in the desired location.
  - Refer to p. 4 "Mounting."
- 6) Connect an antenna, ship's ground or counterpoise.
  - Refer to p. 1 "Antenna for ship" and p. 2 "Ground and counterpoise."
- 8) Connect the control cable and the coaxial cable to the transceiver.
  - Refer to p. 4 "Control cable."
- 9) Perform preset tuning setting. For the AT-130E, also perform emergency tuning setting.
  - Refer to p. 5 "Preset tuning" and p. 6 "Emergency tuning."
- 10) Select the mode switch (S1) to NORMAL mode (center position). Replace the top cover.

## Cable installation

- 1) Remove the 10 screws from the top cover. Remove the top cover.
- 2) Loosen the screws on both cable clamps.
- 3) Set or remove the strain relief inserts corresponding to the diameters of the cables.
- 4) Install the coaxial cable through the top cover cable clamp. Install the control cable through the bottom cover cable clamp.
- 5) After connecting the coaxial cable and control cables, perform preset tuning setting.
  - For the AT-130E, also perform emergency tuning setting.
- 6) After internal adjustments, tighten the cable clamp screws.

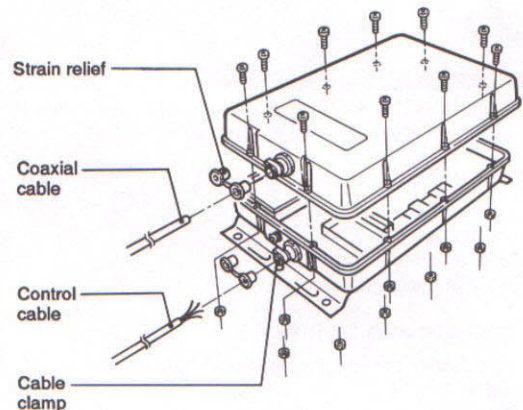

## PL-259 connector

- 1) Slide the coupling ring over the coaxial cable. Strip the cable jacket and pull back to reveal 10 mm of braid.
  - Soft solder the exposed braid and then pull out the jacket.
- 3) Slide the connector body over the cable and solder as shown below.

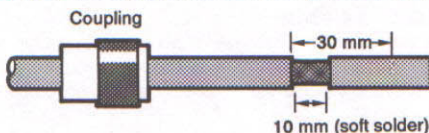

- 2) Strip the cable as shown below. Tin the center conductor the entire length of the exposed braid.



10 mm  $\approx$  3/8 inches

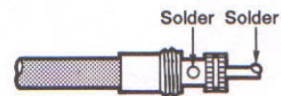

- 4) Screw the coupling ring onto the connector body.

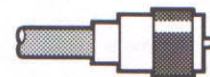

## Control cable

Between the AT-130/E and HF marine transceiver, connect 4 control signal lines as shown at right. To prevent RF feedback, use a 4-conductor shielded cable. Connect the shield line to the [GND] terminal on the transceiver. Icom offers an optional OPC-420 CONTROL CABLE (10 m; 32.8 feet).

Refer to p. 7 "Terminal information" and "Transceiver switch" for details.

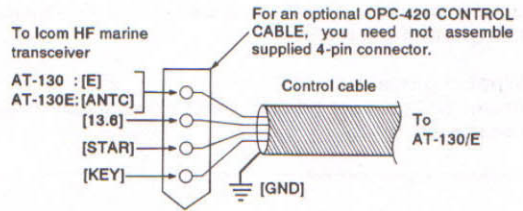

## Cable connections

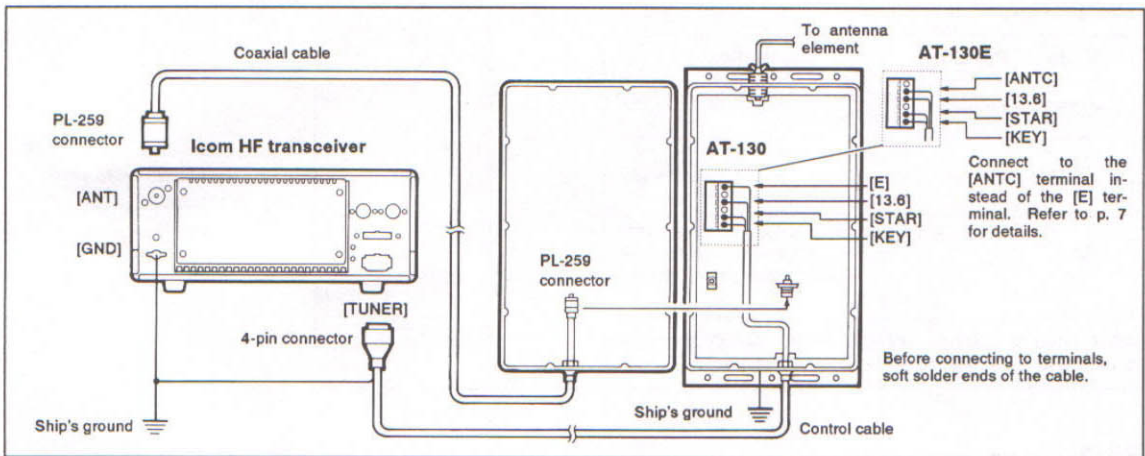

## Mounting

Attach the AT-130/E either horizontally or vertically with one of the water drains facing downwards. After mounting, remove the screw in the water drain.

### Mounting on a mast

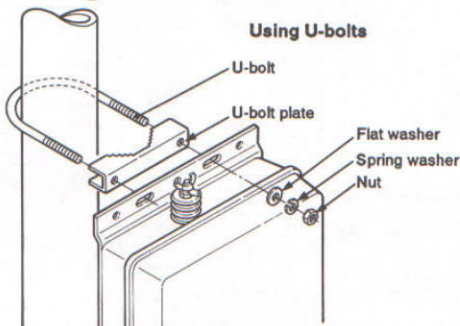

**WARNING:** Mount the AT-130/E securely with the supplied bolts and nuts. Otherwise, vibrations and shocks due to waves, etc. could loosen the antenna tuner, causing personal injury.

### Mounting on a flat surface

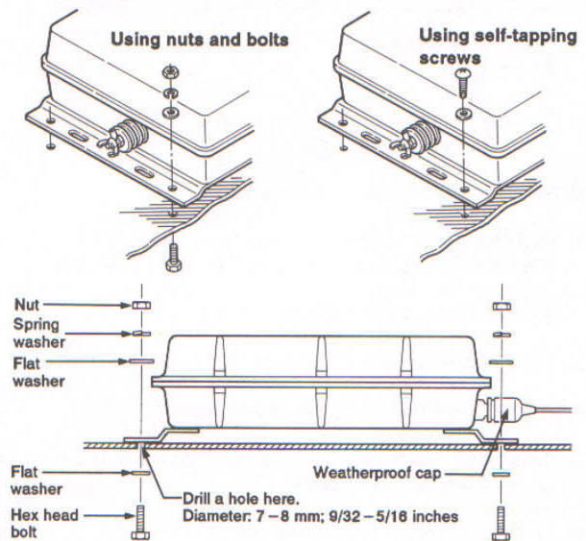

# 3 INTERNAL SETTINGS

## Before internal settings

Before operation, preset tuning setting and emergency tuning setting are required.

### What is preset tuning

Preset tuning setting provides fast tuning on your most-used frequency.

### What is emergency tuning

The Europe version, AT-130E, includes an emergency tuner circuit for 2182 kHz operation separated from the automatic tuner circuit. If any signal from the control cable becomes abnormal, the emergency tuner is automatically selected.

## Mode switch

According to the mode switch (S1), the AT-130/E operates as follows:

Mode	Position	Description
PRESET	Upper	Used only for preset tuning. Refer below for details.
NORMAL	Center	Operates in automatic tuning. For fast tune up, preset switches (S3, S4, S5) information is also used.
OFF	Lower	Operates in automatic tuning only. This mode is for some non-Icom HF transceivers. Refer to p. 7 for details.

After internal settings are performed, select the mode switch (S1) to NORMAL mode (center position).

### Mode switch (S1) location

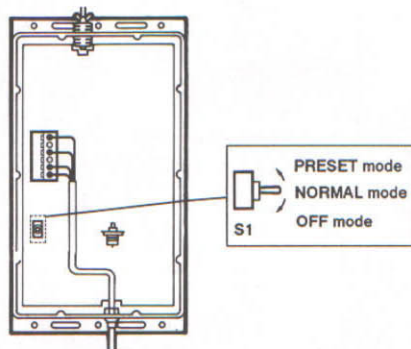

## Preset tuning

**WARNING: NEVER** touch internal parts while transmitting. Stop transmitting when internal adjustments are performed.

- 1) Connect a SWR meter between an HF transceiver and the AT-130/E.
- 2) Confirm the mode switch (S1) is in NORMAL mode (center position).
- 3) Select your most-used operating frequency.
- 4) Push the [TUNE] switch on the HF transceiver.
  - When the AT-130/E succeeds in automatic tuning, an LED (DS24) lights up.
  - Confirm that SWR reading is less than 2:1.
- 5) Make a note of which LED's (DS1 - DS23) light up.
- 6) Select S1 to PRESET mode (upper position).
- 7) Select the preset switches (S3, S4, S5) so that the same LED's light up as in step 5).
- 8) Select S1 to NORMAL mode (center position).

- 9) Replace the top cover of the AT-130.
  - For the AT-130E, perform emergency tuning settings.

### Switch and LED locations

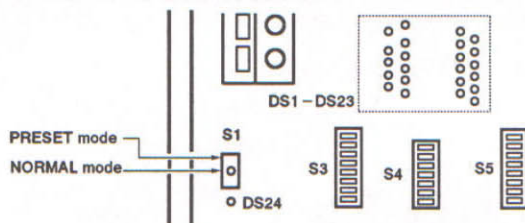

### Switch and LED relationship

S3-1	DS16	S4-1	DS9	S5-1	DS1	OFF position: Lights up
S3-2	DS17	S4-2	DS10	S5-2	DS2	
S3-3	DS18	S4-3	DS11	S5-3	DS3	ON position: Goes out
S3-4	DS19	S4-4	DS12	S5-4	DS4	
S3-5	DS20	S4-5	DS13	S5-5	DS5	
S3-6	DS21	S4-6	DS15	S5-6	DS6	
S3-7	DS22	S4-7	DS14	S5-7	DS7	
S3-8	DS23	—	—	S5-8	DS8	



## Emergency tuning (AT-130E)

For the AT-130E, before operation, perform emergency tuning setting.

**WARNING: NEVER** touch internal parts while transmitting. Stop transmitting when internal adjustments are performed. 2182 kHz is used for distress calls, etc. Listen on the frequency before transmitting.

- 1) Connect an SWR meter between an HF transceiver and the AT-130E.
- 2) Remove the top cover of the AT-130E.
- 3) Select 2182 kHz and AM (H3E) mode for the HF transceiver.
  - Refer to each transceiver's instruction manual for details.

**CAUTION:** If another frequency is selected, the AT-130E may be damaged.

### 13.6 V DC cable

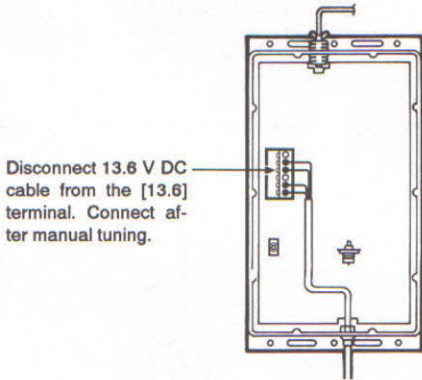

### Selectable pin connections on J2

Select one of following pin connections to obtain minimum SWR reading.

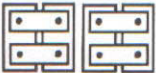

Pin connection before shipping from Icom.



Disconnect all 4 pins on J2 in step 5) above.



- 4) Disconnect the 13.6 V DC cable from the [13.6] terminal. Tape the end of the wire.
  - **NEVER** allow the 13.6 V DC cable end to touch any other parts.
- 5) Disconnect all 4 pins on J2 as shown below.
- 6) Connect a red wire to a pin (J7 – J22) where minimum SWR reading is obtained.
- 7) Connect pins on J2 to obtain a minimum SWR reading.
- 8) Adjust C8 to obtain a minimum SWR reading.
  - To avoid damage to the HF transceiver, DO NOT transmit for more than 5 sec.
- 9) Repeat steps 6) – 8) to obtain a minimum SWR reading.
- 10) Connect the 13.6 V DC cable to the [13.6] terminal.
- 11) Replace the top cover of the AT-130E.

### Red cable layout

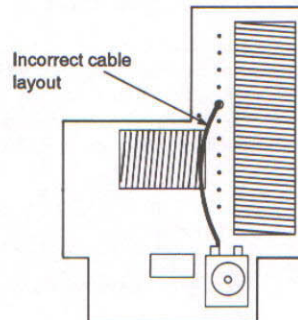
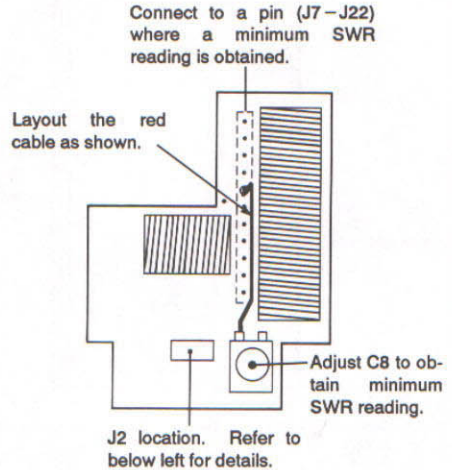

# 4 CONTROL CABLE SIGNALS

## Terminal information

Consider the following points when using a non-Icom transceiver.

Terminal	Description
[E]	⊖ terminal.
[ANTC]	AT-130: No connection. AT-130E: Antenna current detector output from the emergency tuner.
[13.6]	13.6 V DC ⊕ input terminal. Max. current drain 2 A
[GND]	The same voltage as the ground terminal at the bottom. No need to connect from this terminal.
[STAR]	Receives start voltage. Max. current drain 100 mA
[KEY]	Key voltage. Grounded during tuning. Max. current drain 100 mA

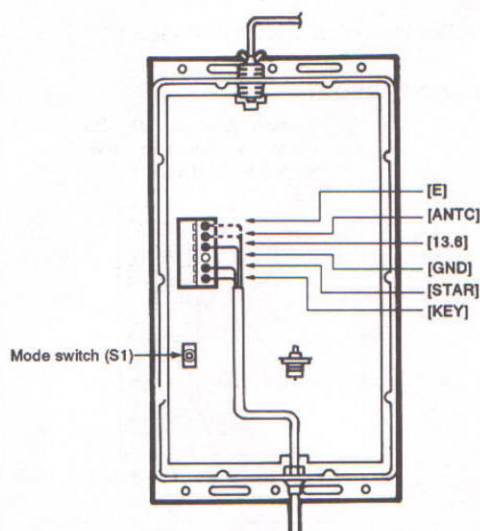

### Start voltage [STAR]

When start voltage (less than 1 V) is received, the AT-130/E begins automatic tuning.

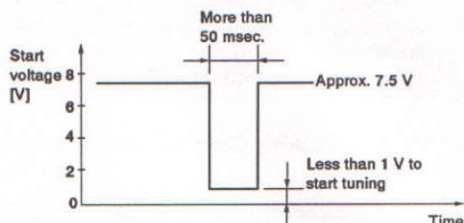

### Key voltage [KEY]

During automatic tuning, the AT-130/E grounds key voltage line, and the HF transceiver reduces output power.

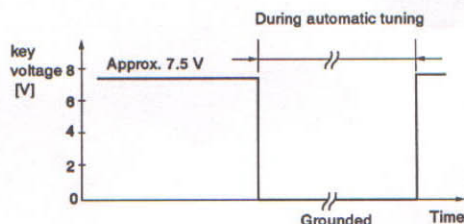

If the key voltage is more than 8 V, select the mode switch (S1) to OFF mode (lower position).

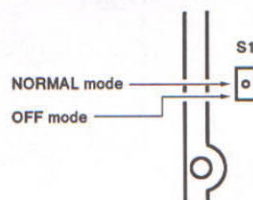

## Transceiver switch

### IC-M700 with serial numbers 2500 and below

In the IC-M700, change the [TUNE] switch setting from the "1" position to the "2" position. Confirm that the [KEY] switch is in the "2" position. Refer to the IC-M700 instruction manual p. 9 for details.

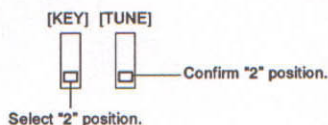

### Other Icom HF transceivers

Some Icom HF transceivers have internal [KEY] and [TUNE] switches. Suitable switch settings for the AT-130/E are performed before shipping.

However, if a non-Icom automatic tuner was previously used, confirm the switch settings. Refer to the instruction manual for details.

### Non-Icom HF transceivers

Select correct settings for the start voltage and key voltage. Refer to your HF transceiver instruction manual for details.

## Inside view

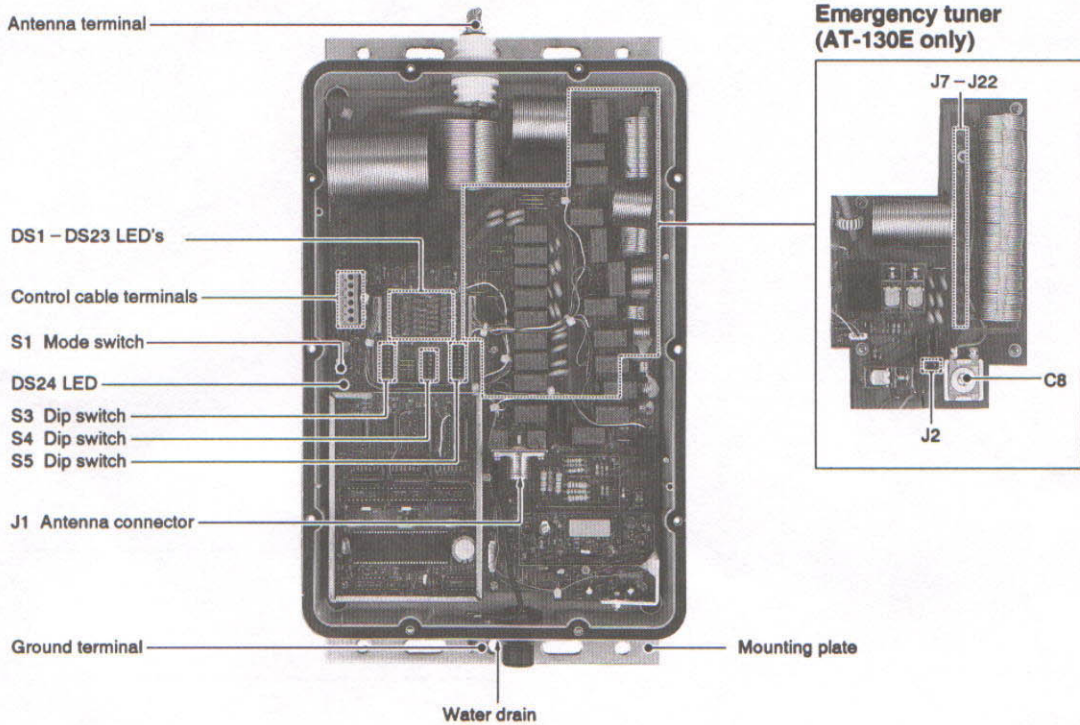

## Specifications

- Dimensions : 230(W) × 340(H) × 80(D) mm  
9.1(W) × 13.4(H) × 3.1(D) in (projections not included)
- Weight : AT-130 2.5 kg; 5.5 lb  
AT-130E 2.7 kg; 6.0 lb
- Usable temperature range : -30°C to +60°C
- Power supply requirement : 13.6 V DC (supplied from HF transceiver)
- Current drain : Max. 2 A
- Frequency coverage : 1.6 - 30 MHz (with 7 m; 23.0 feet or longer antenna element)
- Input impedance : 50 Ω
- Max. input power : 150 W (PEP)  
100 W (continuous)
- Automatic tuning time : Approx. 2 - 3 sec. (general condition) Max. 15 sec.  
Approx. 1 sec. (retuning for a memorized frequency)
- Automatic tuning accuracy : SWR 2.0:1 (after tuning, except for multiples of 1/2 λ)

All stated specifications are subject to change without notice or obligation.

Count on us!

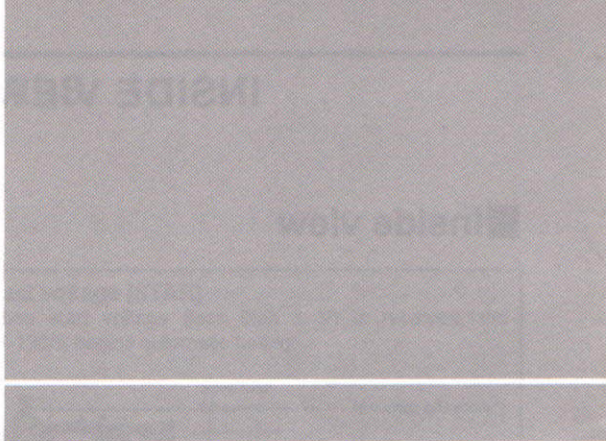

---

---

---

---

---

---

---

---