



ADA188598

NTIS[®]
Information is our business.

INVESTIGATION OF THE USE OF DROGUES TO IMPROVE THE SAFETY OF SAILING YACHTS

U.S. COAST GUARD
GROTON, CT

MAY 87

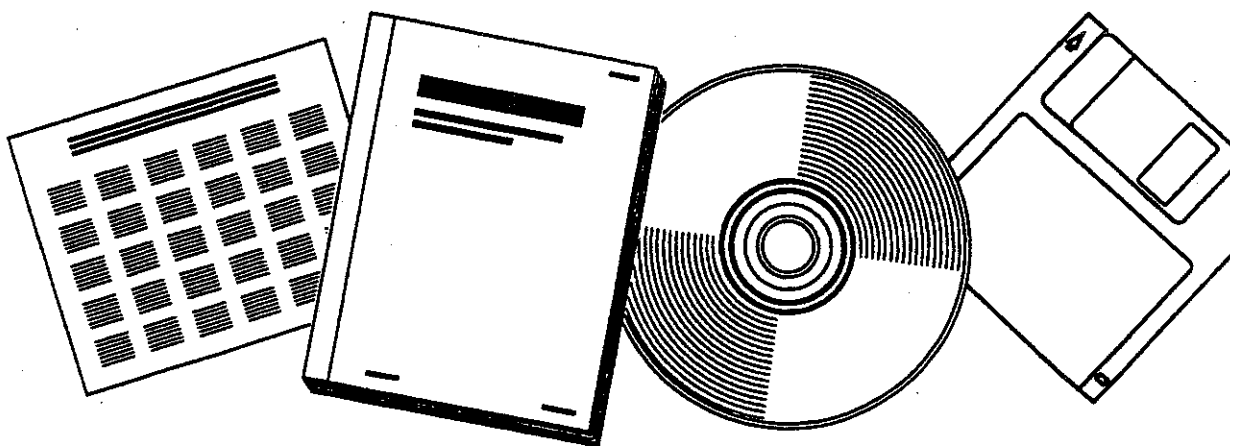

U.S. DEPARTMENT OF COMMERCE
National Technical Information Service

Report No. CG-D-20-87

**INVESTIGATION OF THE USE OF DROGUES TO IMPROVE THE
SAFETY OF SAILING YACHTS**

CAROL L. HERVEY

U.S. COAST GUARD RESEARCH AND DEVELOPMENT CENTER
AVERY POINT, GROTON, CONNECTICUT 06340-6096

AND

DONALD J. JORDAN
CONSULTING ENGINEER

FINAL REPORT
MAY 1987



DISTRIBUTION STATEMENT A
Approved for public release
Distribution Unlimited

This document is available to the U.S. public through the
National Technical Information Service, Springfield, Virginia 22161

Prepared for:

U.S. Department Of Transportation
United States Coast Guard
Office of Engineering and Development
Washington, DC 20593

REPRODUCED BY
U.S. DEPARTMENT OF COMMERCE
NATIONAL TECHNICAL INFORMATION SERVICE
SPRINGFIELD, VA. 22161

AD-A188 598

NOTICE

This document is disseminated under the sponsorship of the Department of Transportation in the interest of information exchange. The United States Government assumes no liability for its contents or use thereof.

The United States Government does not endorse products or manufacturers. Trade or manufacturers' names appear herein solely because they are considered essential to the object of this report.

The contents of this report reflect the views of the Coast Guard Research and Development Center, which is responsible for the facts and accuracy of data presented. This report does not constitute a standard, specification, or regulation.



SAMUEL F. POWEL, III

Technical Director

**U.S. Coast Guard Research and Development Center
Avery Point, Groton, Connecticut 06340-6096**



Technical Report Documentation Page

1. Report No. CG-D-20-87	2. Government Accession No.	3. Recipient's Catalog No.	
4. Title and Subtitle INVESTIGATION OF THE USE OF DROGUES TO IMPROVE THE SAFETY OF SAILING YACHTS		5. Report Date MAY 1987	6. Performing Organization Code
		8. Performing Organization Report No. CGR&DC 02/87	
7. Author(s) CAROL L. HERVEY and DONALD J. JORDAN		10. Work Unit No. (TRAIS)	
9. Performing Organization Name and Address U.S. Coast Guard Research and Development Center Avery Point Groton, Connecticut 06340-6096		11. Contract or Grant No.	
		13. Type of Report and Period Covered FINAL	
12. Sponsoring Agency Name and Address Department of Transportation U.S. Coast Guard Office of Engineering and Development Washington, D.C. 20593		14. Sponsoring Agency Code	
15. Supplementary Notes			
16. Abstract <p style="text-align: center;">Model and full-scale tests were conducted to investigate the use of drogues to prevent breaking wave capsizing of sailing yachts. A mathematical model was developed which simulates the motion of a boat and drogue in regular waves and in a breaking wave strike. A series drogue is recommended for optimum performance based on the results of this study. Design information for both series and conventional drogues is presented.</p>			
17. Key Words capsize safety drogue sailing yachts		18. Distribution Statement Document is available to the U.S. public through the National Technical Information Service, Springfield, Virginia 22161	
19. Security Classif. (of this report) UNCLASSIFIED	20. SECURITY CLASSIF. (of this page) UNCLASSIFIED	21. No. of Pages	22. Price

Form DOT F 1700.7 (8/72) Reproduction of form and completed page is authorized

METRIC CONVERSION FACTORS

Approximate Conversions from Metric Measures

Symbol	When You Know	Multiply By	To Find	Symbol
LENGTH				
in	inches	* 2.5	centimeters	cm
ft	feet	30	centimeters	cm
yd	yards	0.9	meters	m
mi	miles	1.6	kilometers	km
AREA				
in ²	square inches	6.5	square centimeters	cm ²
ft ²	square feet	0.09	square meters	m ²
yd ²	square yards	0.8	square meters	m ²
mi ²	square miles	2.6	square kilometers	km ²
	acres	0.4	hectares	ha
MASS (WEIGHT)				
oz	ounces	28	grams	g
lb	pounds	0.45	kilograms	kg
	short tons (2000 lb)	0.9	tonnes	t
VOLUME				
tsp	teaspoons	5	milliliters	ml
tbsp	tablespoons	15	milliliters	ml
fl oz	fluid ounces	30	milliliters	ml
c	cups	0.24	liters	l
pt	pints	0.47	liters	l
qt	quarts	0.95	liters	l
gal	gallons	3.8	liters	l
ft ³	cubic feet	0.03	cubic meters	m ³
yd ³	cubic yards	0.76	cubic meters	m ³
TEMPERATURE (EXACT)				
°F	Fahrenheit temperature	5/9 (after subtracting 32)	Celsius temperature	°C

Symbol	When You Know	Multiply By	To Find	Symbol
LENGTH				
mm	millimeters	0.04	inches	in
cm	centimeters	0.4	inches	in
m	meters	3.3	feet	ft
m	meters	1.1	yards	yd
km	kilometers	0.6	miles	mi
AREA				
cm ²	square centimeters	0.16	square inches	in ²
m ²	square meters	1.2	square yards	yd ²
km ²	square kilometers	0.4	square miles	mi ²
ha	hectares (10,000 m ²)	2.5	acres	
MASS (WEIGHT)				
g	grams	0.035	ounces	oz
kg	kilograms	2.2	pounds	lb
t	tonnes (1000 kg)	1.1	short tons	
VOLUME				
ml	milliliters	0.03	fluid ounces	fl oz
l	liters	0.125	cups	c
l	liters	2.1	pints	pt
l	liters	1.06	quarts	qt
l	liters	0.26	gallons	gal
m ³	cubic meters	35	cubic feet	ft ³
m ³	cubic meters	1.3	cubic yards	yd ³
TEMPERATURE (EXACT)				
°C	Celsius temperature	9/5 (then add 32)	Fahrenheit temperature	°F

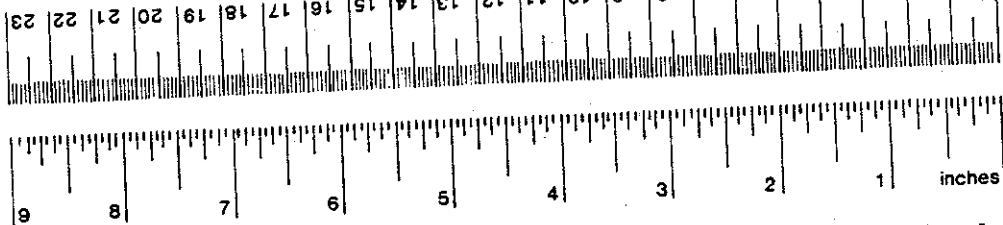

* 1 in = 2.54 (exactly). For other exact conversions and more detailed tables, see NBS Misc. Publ. 286, Units of Weights and Measures. Price \$2.25. SD Catalog No. G13.10.286.

TABLE OF CONTENTS

	<u>Page</u>
1.0 INTRODUCTION.....	1
1.1 The Capsize Problem.....	1
1.2 Breaking Waves.....	2
1.3 Drogues.....	4
2.0 SCALING CONSIDERATIONS.....	6
2.1 Model Scaling.....	6
2.2 Wave Scaling.....	7
3.0 MODEL TESTS.....	8
3.1 Early Work.....	8
3.2 Model Tests in Simulated Breaking Waves.....	12
3.2.1 Introduction.....	12
3.2.2 Test Equipment.....	12
3.2.3 Test Procedure.....	15
3.2.4 Discussion of Results.....	15
3.2.5 Computer Simulation.....	17
3.2.6 Conclusions.....	17
3.3 Circulating Water Channel Tests.....	19
3.3.1 Introduction.....	19
3.3.2 Test Equipment.....	20
3.3.3 Test Results.....	20
3.3.4 Conclusions.....	23
3.4 Hull Drag.....	25
3.4.1 Introduction.....	25
3.4.2 Test Equipment and Procedure.....	25
3.4.3 Test Results.....	27
3.4.4 Conclusions.....	27
4.0 FULL-SCALE DROGUE TESTING.....	33
4.1 Drag Tests of a Series Drogue.....	33
4.1.1 Introduction.....	33
4.1.2 Test Procedure.....	33
4.1.3 Test Results.....	39
4.1.4 Conclusions.....	39
4.2 Fatigue Tests of a Series Drogue.....	39
4.2.1 Introduction.....	39
4.2.2 Test Procedure.....	39
4.2.3 Test Results.....	40
4.2.4 Conclusions.....	42

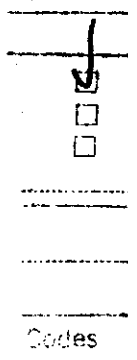

Date	No. of Special	
A-1		

TABLE OF CONTENTS (cont'd)

	<u>Page</u>
4.3 Deployment and Retrieval Test of a Series Drogue.....	42
4.4 Test in Simulated Storm Seas.....	43
5.0 MATHEMATICAL MODEL.....	44
5.1 Introduction.....	44
5.2 Boat and Drogue in Regular Waves.....	45
5.3 Breaking Wave Strike.....	49
6.0 RECOMMENDED DESIGN REQUIREMENTS FOR DROGUE SYSTEMS...	55
6.1 Drogue Size.....	55
6.2 Design Loads.....	56
6.3 Towline and Attachments.....	56
6.4 Boat Design.....	59
6.5 Types of Drogues.....	60
6.6 Sea Anchor Deployed from the Bow.....	61
7.0 CONCLUSIONS.....	61
APPENDIX A - COMPUTER PROGRAM - BOAT IN REGULAR WAVES.....	A-1
APPENDIX B - COMPUTER PROGRAM - BOAT IN BREAKING WAVES.....	B-1
APPENDIX C - ESTIMATING DROGUE SIZE FOR LARGE YACHTS.....	C-1

LIST OF ILLUSTRATIONS

<u>Figure</u>		<u>Page</u>
1	Sailboat Models.....	9
2	Breaking Wave Simulator.....	10
3	Sailing Yacht Model Characteristics.....	13
4	Standfast Model.....	14
5	Diagram of Test Run.....	16
6	Drogue Loads.....	18
7	Test Set-up in Circulating Water Channel.....	21
8	Drogue Models.....	22
9	Comparisons of Measured and Computed Drogue Loads.....	24
10	Forces During Wave Strike.....	26
11	Model Characteristics.....	28
12	Model Hull Drag.....	29
13	Model Hull Drag.....	30
14	Model in Flow Channel.....	31
15	Full-Scale Hull Drag.....	32
16	Series Drogue.....	35
17	Series Drogue Construction.....	36
18	Splicing Methods.....	37
19	Drag of a Series Drogue.....	38
20	Fatigue Test Set-up.....	41
21	Forces on Boat/Drogue System.....	46
22	Computer Simulation - 20-foot Waves.....	47

LIST OF ILLUSTRATIONS (cont'd)

<u>Figure</u>		<u>Page</u>
23	Computer Simulation - 80-foot Waves.....	48
24	Drogue Design Data.....	51/53/54
25	Recommended Drogue Size.....	57
26	Towline Design Data.....	58

LIST OF TABLES

<u>Table</u>		<u>Page</u>
1	Test Results.....	34

INVESTIGATION OF THE USE OF DROGUES TO IMPROVE THE SAFETY OF SAILING YACHTS

1.0 INTRODUCTION

Model tests and full-scale tests were conducted to investigate the use of drogues to prevent breaking wave capsizing of sailing yachts. A mathematical model was prepared which simulates the motion of a boat and drogue in regular waves and in a breaking wave strike.

For this report the term drogue is used to describe a drag device of any type or size deployed from either the bow or stern, and may be used interchangeably with the term sea anchor.

The tests described herein represent the second phase of the investigation. The first phase results are reported in Reference 1. The second phase includes:

1. Tests of larger scale boat models than used in Phase 1.
2. Dynamic tests of drogue models under simulated storm conditions.
3. Further development of the mathematical models.
4. Design, construction and testing of a full-scale series type drogue.
5. Preparation of a proposed design specification for a full-scale series drogue system and for modifications to the boat to accommodate the use of a drogue under survival storm conditions.

Prior to this investigation of the use of drogues, comprehensive model tests were conducted in this country and in England to study the effect of sailing yacht design characteristics on breaking wave capsizing vulnerability. This work is reported in References 1-4. Although it was found that certain design characteristics such as beam/length ratio would adversely affect capsize performance, the effect was relatively small and a slightly larger wave would capsize all the designs. From this work it may reasonably be concluded that design changes which could be incorporated in the sailing yacht fleet in the foreseeable future will not significantly reduce the frequency of capsize. Accordingly this program and a similar program in England was directed toward the use of drogues as a solution which offered the promise of a large improvement in safety and which could readily be applied to the current fleet of sailing yachts.

1.1 The Capsize Problem

There is a long history of breaking wave capsize of

small boats. Accurate and detailed descriptions of many of the events are available in the literature. The greatest number in a single storm occurred in the 1979 Fastnet Race in which 24 boats were sunk or abandoned and 15 lives were lost. Small boats are much more vulnerable than large boats. There are relatively few instances of a vessel over 60 feet being capsized by a breaking wave. In the Fastnet Race where the boats ranged in size from 30 feet to 80 feet, all the capsizes were suffered by boats under 45 feet.

It does not take a so-called rogue wave to cause capsize. In the Fastnet storm, the 30-foot yacht, Grimalkin, running under bare poles, broached and rolled the mast in the water six times before finally capsizing in the 7th roll. She was dismasted and lay inverted for 1-1/2 minutes before righting. Later she capsized again before being abandoned and ultimately sinking. In such a storm there are many waves breaking with sufficient force to capsize a boat of this size. Most breaking wave capsize accidents have involved small sailing yachts because many such vessels cruise or race offshore. However, small fishing vessels have occasionally been capsized. The 55-foot steel lobster boat Fair Wind was caught in a storm 150 miles off Chatham, Massachusetts. She was lying stern to the sea when she was overtaken by a steep breaking wave and pitchpoled. The boat remained inverted and finally sank.

Multi-hull vessels are also vulnerable. The 60-foot lightweight trimaran, Gonzo, was running under bare poles in a storm 250 miles off Cape Cod. She was struck by a wave which broached her and the next wave rolled her over.

It is important to note that most storms, even severe storms, do not create dangerous breaking waves. Sailors who survive such storms may conclude that the tactics they employ, such as heaving to, lying ahull or running off, are adequate to prevent capsize. This is a serious mistake. There is very compelling evidence to show that while a well found boat will survive a storm in non-breaking waves, none of the above tactics will prevent capsize in a breaking wave strike.

1.2 Breaking Waves

In an ocean storm, large waves as such are not a threat to a small boat. Even a very steep wave which can roll the boat violently will not capsize or damage a small sailing yacht. The period of such ocean waves is much longer than the natural roll period of a small yacht or fishing vessel, and rolling motion will damp between waves. Also, there is evidence that with all sail off the wind forces are not a very important factor. Most of the time the vessel is in the lee of large waves. The blast which strikes the boat as it passes over the crest is of short duration and in the Fastnet storm sailors reported no serious problems associated with the wind except, of course, the effect of the wind on the waves.

In many storms most of the waves are irregular and unstable; that is, no single wave maintains its shape for very long. Sailors report a wave as having suddenly humped up out of a flat spot and forming a crest which cascaded down three sides of the wave. A variety of unusual shapes can be seen in photographs of storms at sea. Irregular waves as such do not pose a particular threat. It is the breaking wave which is dangerous.

The characteristic of a breaking wave which can cause capsize is the fact that a mass of water on the crest of the wave or tumbling down the face of the wave is moving at approximately the speed of the wave. For a wave with a wave length of 300 feet, this water can strike the boat at a speed of 20 knots or more. A small boat lying ahull in non-breaking waves of any shape moves more or less with the surface water. It will not be struck by a large mass of moving water and therefore will not capsize, whereas a boat struck by a breaking wave can be violently thrown into the trough and capsized.

Breaking waves can have many forms. The wave height and wave speed can differ for each storm. Of particular importance with regard to capsize potential are the shape of the front face of the wave and the momentum of the water in the breaking crest. Momentum is defined as the mass of moving water times its velocity. The force imparted to a boat struck by a breaking wave is largely determined by this quantity. The most familiar breaking wave is the cup-shaped breaker seen on a beach. This wave forms as a fast-moving ocean swell and is slowed down by the shelving bottom. In an ocean storm the waves are not slowed down but are actually accelerated by the wind. The pressure forces of the wind on the wave surface causes the wave to steepen until a small portion of the crest breaks and forms a whitecap. A whitecap is a mild form of breaking wave in that some of the water has been accelerated up to wave speed. A whitecap on a very large ocean storm wave may have enough force to capsize a life raft. When two or more storm waves intersect they may combine to form a larger wave which in some circumstances may then become a dangerous breaking wave. From photographs of storms at sea and from observations of smaller wind-driven waves, it appears that most of the breaking waves in an ocean storm do not resemble a slow-moving cup-shaped plunging breaker but might be described as an enlarged whitecap, that is, a large, high-speed wave with only the top breaking. However, waves of many different shapes have been reported from time to time.

Breaking waves formed in a towing tank or formed by the wake of a powerboat, as described later in this report, do not represent the complete spectrum of wave types which might be encountered in an ocean storm. However, it is believed that such simulated storm waves can be used to evaluate survival gear such as drogues provided that the testing is supported by an adequate theoretical framework.

1.3 Drogues

There are many references to drogues and sea anchors in the literature of the sea, going all the way back to ancient times. For the most part this equipment was not carried aboard as emergency gear but was jury rigged when the vessel found itself in dire straits, such as the American privateer David Porter in the war of 1812. She "took a square sail boom spanned at each end with a four inch rope, and with the small bower cable made fast to the bight of the span, the other end being made fast to the foremast, the boom was thrown overboard and run out some sixty fathoms, the effect was miraculous. The boom broke the force of the waves and kept the schooners head to the sea so she rode like a gull till the storm abated." However, in the days of commercial sail almost all vessels which went to sea were over 80 feet and of heavy displacement. Such vessels are not very vulnerable to breaking wave capsizes and there are few reported instances of such disasters.

In the early 1900s, stimulated by Joshua Slocum's circumnavigation, yachtsmen began to make ocean voyages in small boats. The danger of breaking wave capsizes was recognized and some sailors developed tactics to cope with the threat. Many of us who spend winter nights on vicarious cruises are familiar with The Venturesome Voyages of Captain Voss in which he tells of his adventures in the dugout canoe, Tilikum, and the yawl Sea Queen. He credits the sea anchor for his survival on several occasions and gives specific instructions for its design and use. In his worst encounter he rode the ultimate storm, a major typhoon, for hours with no damage until finally his riding sail failed, the sea anchor broke away and he lay ahull. Shortly after he was struck by a breaking wave and capsized.

In recent years the number of small boats that go to sea has increased dramatically. Most boats do not carry a drogue as emergency equipment. When caught in a storm most sailors lie ahull. Some report that the boat rode well with a makeshift drogue such as 150 feet of 1/2-inch chain on the end of 50 feet of nylon line. Many report that towing simple warps is ineffective. One very experienced sailor has developed a system of three drogues streamed simultaneously: a spinnaker pole and small anchor at 200 feet, two tires and a medium anchor at 300 feet, and two tires and a heavy anchor at 400 feet. He reports that before deploying this rig in a severe storm the spreaders were driven into the water three times but with the drogue the boat rode easily.

Multi-hulls (trimarans and catamarans) are now making numerous ocean voyages. In fact this type of yacht now holds many records for speed of passage. Unfortunately a number of these vessels have been lost as a result of breaking wave capsizes. Unlike a conventional yacht, a multihull does not right itself after capsizes. One experienced couple, the Casanovas, has experimented with the use of a large (24 foot)

parachute deployed from the bow of their trimaran. They report that they have ridden out several severe storms with this rig.

Despite these reported examples of successful use of drogues, few boats carry such equipment as emergency gear. In the 1979 Fastnet race none of the boats were so equipped. Organizations such as the National Yacht Racing Union in the U.S. and the Royal Ocean Racing Club in England do not require participants in an ocean race to carry such equipment. There is, however, the organization, the Royal National Lifeboat Institution, in England that specifies a drogue as required emergency gear on their motor lifeboats. They have used the equipment for many years to prevent broaching and capsizing when running an inlet with breaking waves. They have a firm specification for the gear and their crews are trained in deploying and retrieving the drogue.

As part of this report it is important to consider the question of why drogues have not been developed and accepted as a standard item of emergency equipment up to the present time. The following reasons seem to be of the greatest significance.

1. Breaking waves capsize is relatively rare, and many sailors survive storms by lying ahull or by running off. They do not perceive the need for more gear.

2. There is no firm specification for a drogue. When a makeshift arrangement has been tried it often has not worked and in some instances has made the situation worse.

3. Prudent sailors are aware that a drogue can impose high loads on the boat. Since they do not know the magnitude of the loads they are reluctant to take the risk.

4. In a survival storm the crew is often tired and disorganized. If the drogue is difficult or dangerous to deploy they are unable to handle the job.

The research program described in this report is intended to address these concerns and to provide the information needed to make a rational decision on emergency equipment for the prevention of breaking wave capsize.

2.0 SCALING CONSIDERATIONS

2.1 Model Scaling

The boat models used in this program were made to scales of 1/43, 1/32, and 1/10. For a model test to correctly simulate a full-scale event it is necessary that all the forces on the full-scale boat be scaled down by the same ratio. The important forces are the gravity forces, pressure forces, inertia forces and viscous forces. By constructing the models with the correct weight, stability and moment of inertia about the roll and pitch axes, it is possible to correctly scale all the forces except the viscous forces. Thus models can be tested at the correct Froude number (F_r) but not at the correct Reynolds number (R_e). In a capsize event, the gravity forces, pressure forces and inertia forces predominate. Viscous forces, which largely affect skin friction drag, should have little effect on the trajectory of the boat. As a check on the possible effect of R_e , similar tests were conducted on a 1/32 scale and 1/10 scale model of the same boat. No significant differences were noted. It is believed that the model tests can be used to predict the full-scale capsizing behavior with an acceptable accuracy.

Froude number, F_r , is the ratio of the inertial forces to the gravity forces, i.e.,

$$F_r = \frac{V}{\sqrt{gL}}$$

where V is velocity, g is the acceleration of gravity, and L is the relevant length parameter. Dynamic similarity principles have shown that if geometric similarity is maintained, length, time, and force will scale proportionately. Thus,

$$F_r(\text{full-scale}) = F_r(\text{model}), \text{ or}$$

$$\frac{V}{\sqrt{L_{fs}}} = \frac{V}{\sqrt{L_m}}$$

If we define a scale factor, α , then

$$\frac{L_m}{L_{fs}} = \alpha,$$

and therefore

$$V_m = \sqrt{\alpha} V_{fs}.$$

Noting that for deep water waves $L = 5.12T^2$, we can show

$$T_m = \sqrt{\alpha} T_{fs}.$$

Model characteristics were scaled as follows:

Length	α
Area	α^2
Force	α^3
Displacement	α^3
Moment (Stability)	α^4
Moment of Inertia	α^5

2.2 Wave Scaling

Two types of waves were used for this test program; natural wind-driven waves formed on local bodies of water, and a continuous breaking wave formed by the wake of a power boat.

To test the 1/10 scale model in conditions simulating ocean storm waves driven by a 60 mph wind, it was necessary to select natural waves 3 feet high and a wind of 19 mph. It was not difficult to approximate these requirements in actual tests. Visually, 3-foot wind-driven waves appear to be generally similar in shape and behavior to large wind-driven waves. The wind forces cause each wave to form a cusp-shaped crest which grows and steepens until it collapses forming a whitecap. As with the boat models, all the forces within the waves scale correctly except the viscous forces. It appears that viscous forces do not have a large effect on wind-driven wave shape at wave heights above 1 or 2 feet. The effect of Reynolds Number on wind-driven waves in this size range has not, to our knowledge, been studied in detail. For the purposes of this investigation it is believed that the scaled natural waves will provide useful information regarding full-scale experience.

The second type of wave used in this investigation is a breaking wave formed by the wake of a power boat. The size and wave crest momentum of the wave could be varied by changing the type of powerboat or the speed. A wave was chosen which would violently capsize the models when no drogue was used. Scaled to full size it would represent a breaking wave 20 to 30 feet high moving at a speed of 20 to 25 mph. The test wave had a large mass of moving water in the crest and thus represented a very dangerous configuration. At this time no information is available which would permit a more accurate simulation of a full-scale breaking storm wave. Perhaps the best that can be said is that the breaking wave used for the tests would capsize the models with as much and probably more violence as the Fastnet capsizings described by the crews of the affected yachts.

3.0 MODEL TESTS

3.1 Early Work

Because of the danger and difficulty of studying sailing yacht behavior in breaking seas, model tests have been used. To conduct such tests, it is necessary to model an entire system; boat, drogue, line, wind, and sea conditions. This was accomplished according to the scaling principles discussed in the previous section.

The model tests conducted by Jordan, reference 1, examined the effect of boat length and design on capsize propensity. For these tests he modeled three boats which span over 50 years of yacht design, including; Tally Ho, winner of the 1927 Fastnet Race and a heavy traditional cutter design, a New York 30 design from the 1930's, and a modern yacht, the well-known Standfast design. The three models used are shown in Figure 1. The models were 12 inches long representing a scale of 1/43. In addition, the New York 32 and Standfast were built in 16" lengths, representing a scale of 1/32. All models were constructed of balsa and weighted to give the correct dynamic characteristics.

The models were tested under simulated breaking wave conditions. To do this, a horizontal jet of water was discharged into a static pool of water. The horizontal jet was generated by permitting a quantity of water to fall vertically and then deflecting the water from a vertical to a horizontal direction by a curved ramp. A schematic of the setup is shown in Figure 2. Several hoppers of different heights were used during the test to provide different jet velocities.

Results of these early model tests indicated that size played an important role in the ability of a sailboat to resist capsize. This is not surprising if you consider that the kinetic energy necessary to capsize any boat design will vary as the fourth power of the boat length. Thus a 60-foot sailboat requires sixteen times as much kinetic energy from a moving wave crest as a 30-footer in order to capsize.

Another aspect of the early model work was to investigate the effect of design variations on capsize; variations in mast weight, displacement, freeboard, keel design, and the relationship of beam and center of gravity were examined on the previously described models. Using the hopper arrangement, the models were tested to examine the differences in behavior with respect to hull design. The Tally Ho, New York 32, and Standfast models were used. The three designs had about the same capsize performance, despite varying design features. It should be recognized that this type testing is not sufficiently sensitive to pick up small differences in capsize vulnerability.

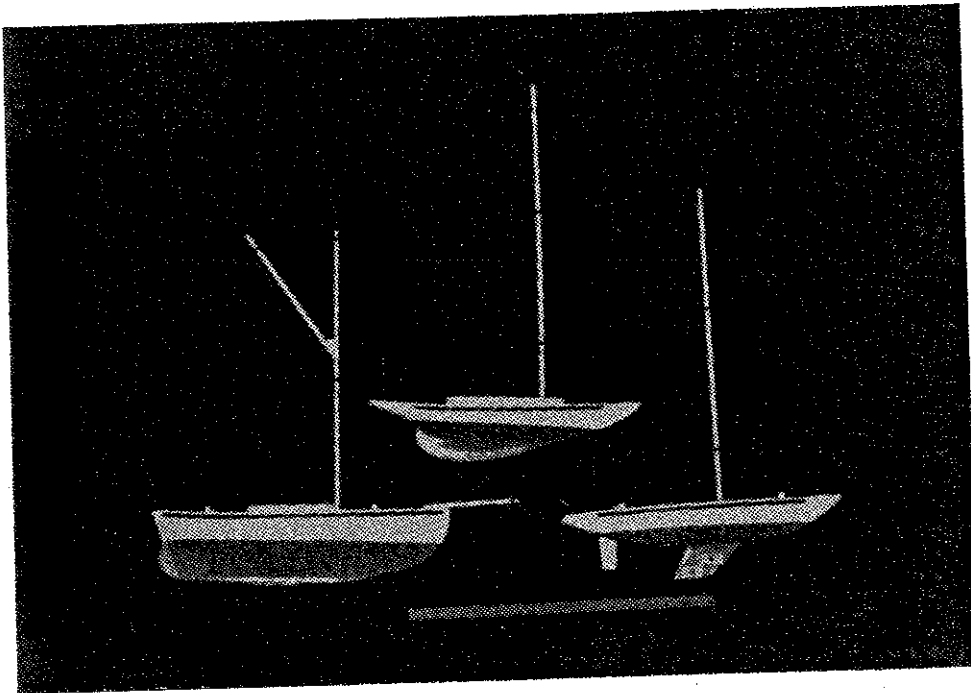

FIGURE 1. Sailboat Models

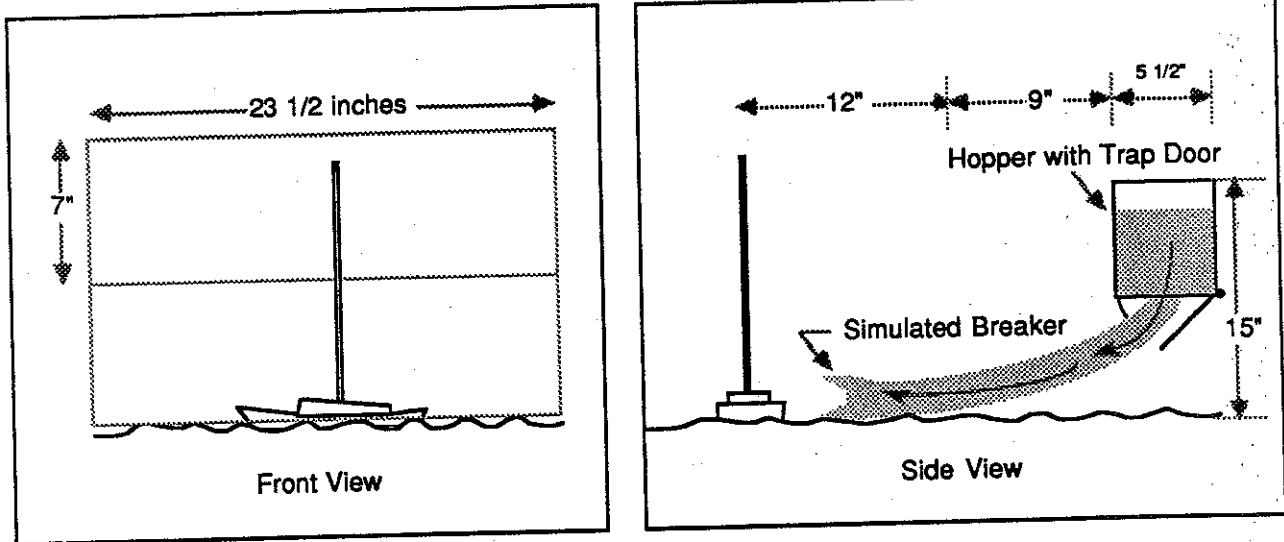

FIGURE 2. Breaking Wave Simulator

Similar studies have been carried out by the joint SNAME/USYRU Project for Safety from Capsizing (Refs. 3 and 4) and by the University of Southampton in England under the sponsorship of the Royal Ocean Racing Club (Ref. 2). These tests were conducted in a towing tank using computer-generated breaking waves. Models with various hull forms and ballast configurations were tested. Although certain design parameters such as beam-to-length ratio appeared to have a measurable effect on capsize vulnerability, no major improvements were found. A slightly larger wave would capsize all the designs.

Research done by the British has led to the conclusion that "although discernible trends in resistance to capsize have been determined, no form or ballasting combination consistently resisted capsize in the 0.42 m. high wave. [This corresponds to a 18-foot wave full scale.] This suggests that alterations in form which improve capsize resistance may be rendered ineffective by a relatively small increase in breaking wave height..." (Ref. 2).

This conclusion is the same one reached in Jordan's early work, i.e., that moderate design changes could not produce significant resistance to capsize. Therefore, it was decided to investigate the use of sea anchors and drogues, devices which would hold the vessel in a safer orientation to the wind and waves and thus prevent capsize.

For the initial drogue testing, the horizontal water jet was used to simulate the breaking wave. The boat was positioned so that the wave front struck at 45 deg. from astern and the drogue was deployed 15 deg. from the wave direction. The model drogue consisted of a simple plastic disk with a wire shaft. It was found that a drogue with a diameter less than 10 to 15% of the length of the boat, i.e., 3 to 4-1/2 ft. for a 30-ft. boat, would not exert enough force to pull the stern into the wave face. As a result the boat would broach and capsize. However, a drogue with a diameter equal to or greater than 10 to 15% of the length of the boat would pull the stern into the wave and prevent capsize.

These tests were run with a relatively stiff towline. When the model towline was provided with elasticity simulating a full-scale nylon line, the load would not build up as quickly and the model would often capsize. In the actual case the towline would be somewhat prestretched at the time of wave strike. It was apparent that a better method of testing was needed to study this effect.

For the second series of tests, which are described in detail in Ref. 1, the models were struck by a breaking wave formed by the wake of a towed dinghy. Without a drogue all the models would be capsized. When struck abeam they would often roll through 360 deg. When struck on the quarter they would sometimes pitchpole end over end. Various types of drogues were

tested. For the conditions under which these tests were conducted, it appeared that a disk drogue 3 to 4-1/2 ft. in diameter or an equivalent cone, parachute or series drogue would prevent capsizing of a 30-ft. boat in almost all cases whereas a 2-ft. diameter drogue would permit the boat to broach and capsize in approximately half of the wave strikes. However, the boat could be capsized with any drogue if there was too much slack in the towline at the time of wave strike. As discussed later in this report, it is felt that in the real case it is unlikely that there would be too much slack in the towline, particularly if a series type drogue is used.

The overall conclusion of this early testing was that a properly designed drogue could prevent capsizing. Continuing effort was devoted to confirming this result with a larger model and developing and testing a full-scale drogue with optimum characteristics.

3.2 Model Tests in Simulated Breaking Waves

3.2.1 Introduction. Reference 1 describes tests of sailing yacht models in breaking waves. For these tests the largest model was 16.1 inches in length. It was considered desirable to repeat these tests with larger models to improve the accuracy and to confirm that there are no effects of scale which would significantly alter the conclusions. For the tests described in this section, a model with an overall length of 36 inches was used, thus the effect on Reynolds No. was more than doubled from the previous tests.

The object of these tests was to investigate the dynamic behavior of a sailing yacht model when it was struck by a breaking wave, to evaluate the effect of using a drogue, to obtain information on the loads on the boat and drogue, and to provide data for a computer simulation which would aid in interpreting and projecting the test results.

3.2.2 Test Equipment. The model used for these tests was intended to represent a typical modern sailing yacht such as those capsized during the 1979 Fastnet Race. For convenience, the model hull of a "Huson" sailing yacht was purchased and then modified to have similar dynamic characteristics to the "Standfast" full-scale yacht design. The model was 36 inches in length or 1/14.3 scale of a 43-foot "Standfast" yacht. The characteristics of the model are listed on Figure 3 and a photograph is shown on Figure 4.

The model was equipped with a spring-loaded wand which was connected to the drogue towline in such a manner that a load in the towline would deflect the wand. For most of the testing a simple disk-type drogue was used. This drogue was 6 inches in diameter. If scaled to "Standfast" size it would represent a cone or parachute drogue of approximately 7 feet in diameter.

	Model	Standfast
L.O.A. (ft.)	3	43
Draft (ft.)	0.47	6.7
Displacement (lbs.)	7.5	22,000
Ballast (lbs.)	3.7	11,100
Initial Stability $\frac{\text{ft. lb}}{\text{deg}}$	0.04	1,600
Period in Roll	1.1	4.1 — 4.4

FIGURE 3. Sailing Yacht Model Characteristics

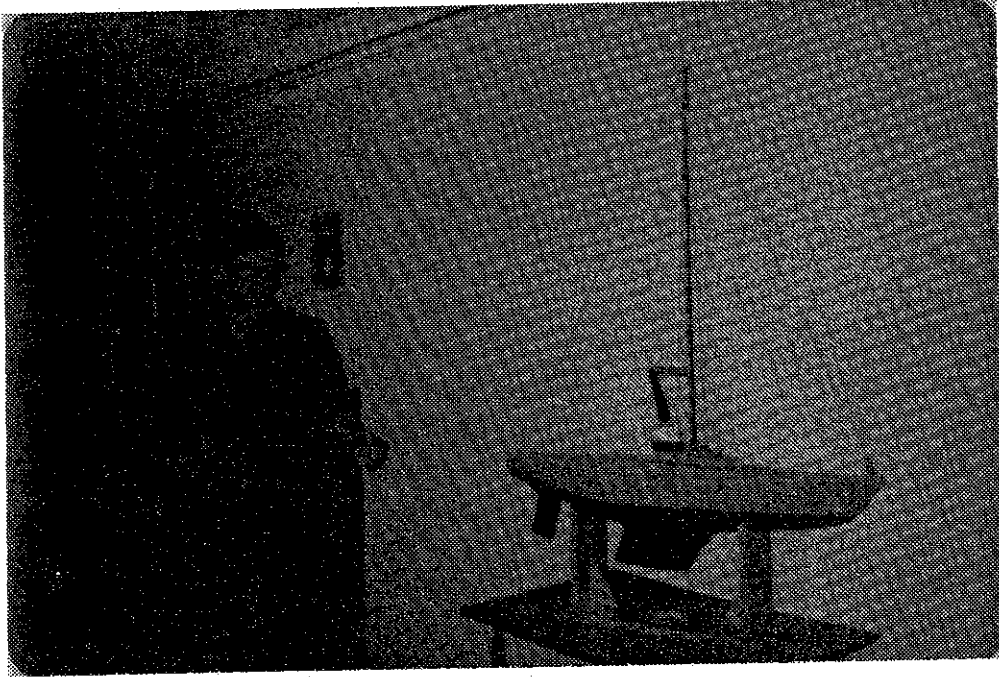

FIGURE 4. Standfast Model

3.2.3 Test Procedure. It was hoped that it would be possible to find natural breaking waves large enough to capsize the model. At the eastern entrance to Long Island Sound there is an area called the Race in which the currents are such that breaking waves often form. The model was placed in these waves on two occasions but the conditions were not severe enough to cause capsize.

It was then decided to capsize the model with the wake of the R&D Center 42-foot research boat. Six 250 lb. cement mooring blocks were placed in the aft end of the cockpit to prevent the boat from planing. At a boat speed of about 10 knots the boat wake formed a breaking wave 2 to 3 feet high, moving at a speed of approximately 11 ft/sec near the boat and tapering off with distance. The wave had a large mass of water in the crest moving at or above the wave phase speed.

The tests were conducted in the Thames River at New London, Connecticut. There were no significant natural waves although the wind was gusty at 10 to 20 mph. For a typical run, the model was placed in the water and the boat was driven past at a distance of 30 to 40 feet from the model. The model was approached from the quarter as shown in Figure 5, so that the wake would strike the model from the direction of the wind. High-speed movies taken at 32 frames/sec were used to record each wave strike.

3.2.4 Discussion of Results. Although it was not possible to capsize the model in natural waves in the Race, this series of tests confirmed an important conclusion presented in reference 1: if a drogue is used, it should be deployed from the stern rather than from the bow. With the drogue deployed from the stern, the model lay stern to the wind and sea. When the same drogue (or sea anchor) was deployed from the bow, the bow tended to fall off whenever the towline was slack. A 2-foot parachute (28 ft. diameter full scale) was tested in an effort to hold the bow into the sea but this did not make a significant improvement. The bow continued to fall off when the boat was in the trough.

The remainder of the tests were conducted in the Thames River. Without a drogue, the model would lie abeam to the wind. When struck by the wake of the boat, the model would be violently capsized, rolling through 360 degrees. It was obvious that there was much more energy in the wave crest than was necessary to marginally capsize the model.

With the 6-inch diameter drogue deployed from the stern, the model was pulled stern first through the breaking wave with no capsize in most instances. However, for several wave strikes the towline had so much slack that the model was

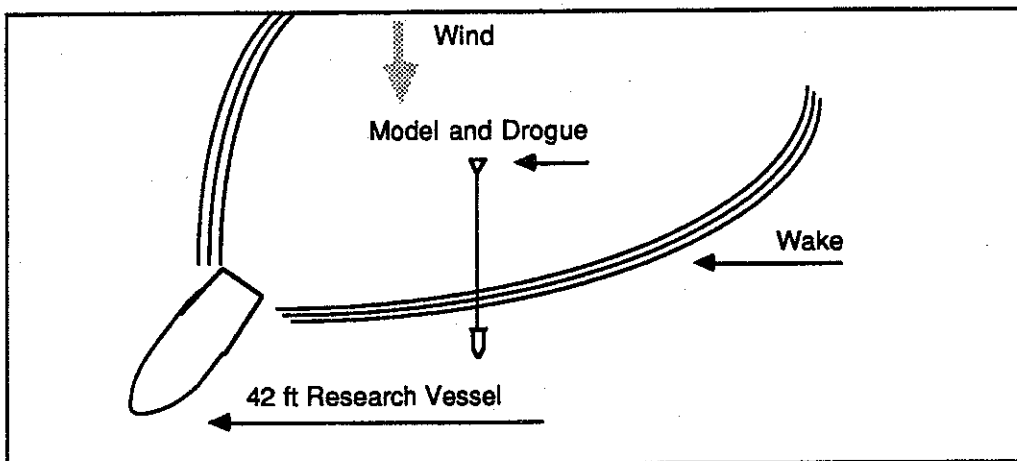

FIGURE 5. Diagram of Test Run

capsized before the drogue exerted any force. It is probable that this result is an artifact of the test situation since in actual storm conditions the boat will be riding large regular waves, and the towline should have little slack as the next wave crest approaches.

The deflection of the spring-loaded vane to which the towline was attached was determined by analysis of the movie frames. For two of the runs the vane deflection has been converted to pounds force and the results are shown on Figure 6. It will be noted that the maximum load for one of the runs is about equal to the displacement of the model, whereas for the other run the load is less than half the displacement. In the latter case the model was farther from the research boat and the wake had less energy.

3.2.5 Computer Simulation. A study of the moving pictures of breaking wave strikes in this test series and the tests reported in reference 1 shows that the model is often brought up to wave speed before the load in the drogue builds up. The horizontal component of the buoyancy force as the model rides up the wave face and the impact force of the breaking wave crest are of such a magnitude that the model is accelerated up to wave speed in a very short distance, too short to allow the drogue to develop much load. Then, as the model moves with the wave crest, the towline tightens and the drogue takes up the load. Initially, the largest portion of the load is the inertia load associated with decelerating the model from wave speed. To this must be added the horizontal component of the buoyancy force which acts until the boat is pulled over the top of the wave crest. From then on most of the drogue load results from the boat being dragged backwards through the surface water which is still moving at a speed close to wave speed behind the crest.

A computer model of the above sequence of events will be discussed in a separate section. It is not possible to directly relate the computer simulation with the actual load measurements since the velocity of the test wave at the model location was not accurately determined. On Figure 6 the computed loads at two assumed wave velocities are plotted together with the measured drogue loads.

It should be noted that for these tests the elasticity or spring rate of the drogue towline was not properly simulated. A true scale model of a 3/4-inch diameter nylon towline would have a spring rate about 1/10 that of the model towline used there. This would reduce the peak loads.

3.2.6 Conclusions. It is apparent that this method of conducting breaking wave tests on model boats is a useful and economical technique. Breaking waves were created which capsized the 36-inch model with as much violence and severity as that experienced by the boats in the 1979 Fastnet Race. Definitive records of the capsize dynamics were obtained on movie film. The weakness of this kind of testing is the fact that the boat and drogue are not riding on large regular waves prior to the

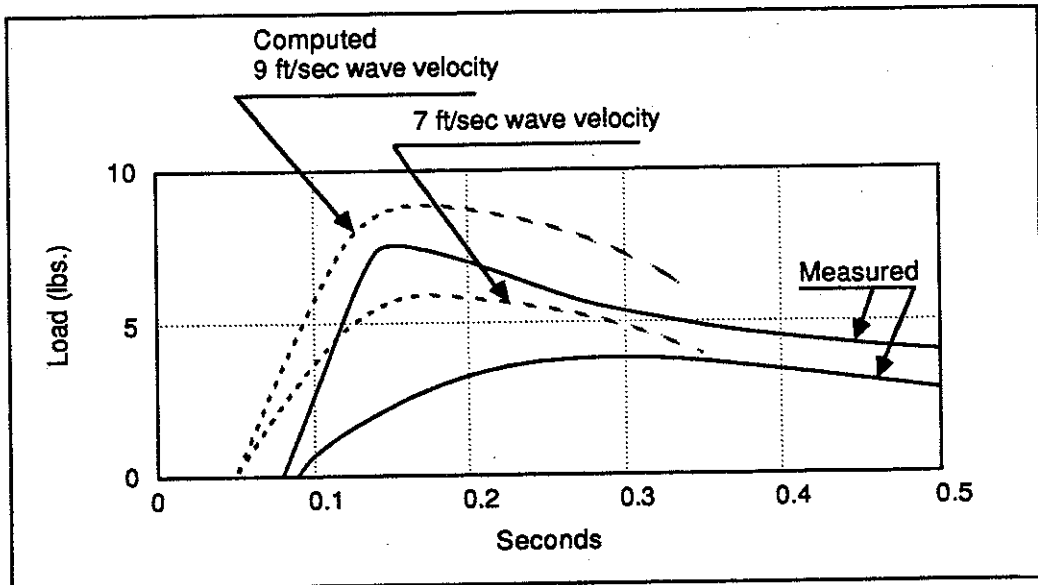

FIGURE 6. Drogue Loads

breaking wave strike. Thus the amount of slack in the drogue towline may not represent a true storm situation.

The tests clearly showed that a drogue deployed from the stern can pull the boat through the breaking wave crest without capsize. However, if the towline has excessive slack at the time of the wave strike, the boat can be capsized before the drogue pulls. The computer simulation of a boat/drogue system riding regular waves indicates that the towline should have little slack at the time of wave strike. It would be desirable to conduct model tests under natural wave conditions to confirm this analysis.

A very important observation emerging from these tests and the tests of reference 1 is that in a severe breaking wave strike, the boat can be brought up to wave speed before the load builds up in the drogue towline. This fact provides a "worst case" situation which in combination with a simple computer simulation, can be used to predict a maximum design load for any specific boat, drogue and wave combination. Using this concept, we can calculate that a 30-foot boat trailing a 4-foot diameter drogue could experience a maximum drogue load of 7800 lbs. if struck by a breaking wave with a wave length of 300 feet and a crest velocity of 39 ft/sec. This "worst case" load estimate applies to relatively small boats, perhaps under 15,000 lbs. displacement, where the mass of the boat is small compared to the mass of the water in the breaking wave crest. For boats with higher displacement it is reasonable to assume that the acceleration caused by the breaking wave strike will be less and thus the relative drogue load should be smaller.

The tests described in this section provide an initial basis for the design of a full-scale drogue system for sailing yachts and other small vessels. Further model tests in natural waves would be useful.

3.3 Circulating Water Channel Tests

3.3.1 Introduction. An investigation of the use of a drogue to prevent breaking wave capsize must consider two distinct operating conditions: (1) the long time exposure to regular storm waves, and (2) the infrequent breaking wave strike. The tests described in this section relate to the first condition, in which the boat/drogue system rides for the duration of the storm, possibly 10 to 20 hours, in waves with a height of 15 to 20 feet and a wavelength between 150 to 300 feet. The object of these tests was to study the transient load in the drogue towline and to evaluate the motion of several types of drogues with particular reference to the vulnerability to fouling or tangling, and to mechanical failure from fatigue or wear.

In regular waves, the particles of water near the surface of the wave move in a more or less circular path, forward at the crest and backward in the trough, with relatively

little net motion in the direction of travel of the wave. If the boat is small in comparison with the wave, i.e., has a waterline length less than a quarter of the wavelength, and if the boat is not moving through the water, as is the case with the drogue deployed, the motion of the boat will be similar to the motion of the water particles in the wave surface. The boat will move in a more or less circular path in the vertical plane. Superimposed on this circular path will be a relatively small drift to leeward resulting from the force of the wind on the hull and rigging and from the drift which occurs in the surface water of storm waves.

To study the motion of the drogue under these conditions it is necessary to impart the same oscillating motion to the drogue towline as it would receive from the boat. It was determined that a close approximation to the horizontal velocity variation of the boat is a simple sine function plus a constant drift velocity. For the tests described in this section, the horizontal velocity variation was provided by attaching the drogue towline to the end of a rotating arm and the drift velocity wave obtained by adjusting the velocity of the water in the flow channel.

3.3.2 Test Equipment. The tests were conducted in the Circulating Water Channel (CWC) at the U.S. Coast Guard Academy in New London, Connecticut. This facility is described in reference 5 and provides a flow channel 2 feet deep by 4 feet wide by 12 feet long with a maximum flow velocity of 8 feet/sec. The arrangement of the test setup is shown in Figure 7. The drogue towline was led from the drogue through an eye located at the end of the rotating arm, and from there it was led to the load cell. The arm was driven by a variable speed electric motor. As the arm rotated the towline received a sinusoidal variation in horizontal velocity. Wave height was simulated by varying the length of the rotating arm, wave length was simulated by adjusting the rotational arm speed, and drift velocity was varied by adjusting the flow rate in the channel.

A variety of drogue designs were tested including cone drogues with both rigid and flexible hoops, parachute drogues, and a novel design called a series drogue. The series drogue consisted of a large number of flexible cones attached to a line with a weight at the end. The drogue models were made of 0.0015-inch polyethylene material and were heat welded to the proper shape. The elasticity of the towline was simulated by the use of rubber strands of the correct dimensions. Figure 8 shows several of the drogue models.

3.3.3 Test Results. The dynamic behavior of the various drogue designs under simulated storm conditions was recorded by taking video pictures through the glass wall of the flow channel. It was found that the cone and parachute drogues would fill properly when the towline was taut but would collapse and tend to reverse direction during the portion of the cycle when the towline went slack. On occasion the shroud lines would

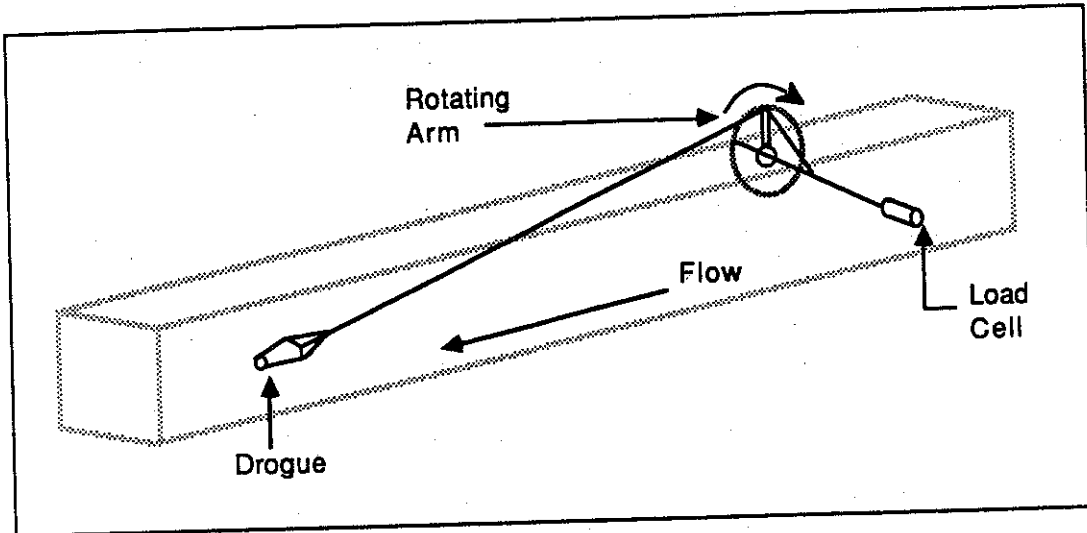

FIGURE 7. Test Setup in Circulating Water Channel

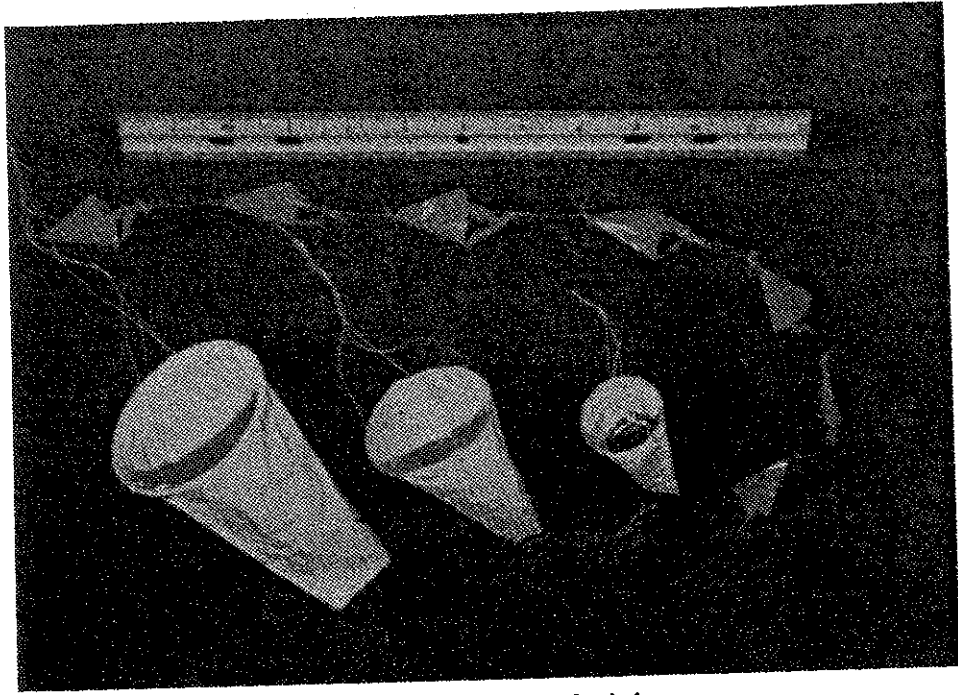

FIGURE 8. Drogue Models

foul and prevent the drogue from opening properly when the towline again became taut.

The Icelandic Directorate of Shipping undertook a program of liferaft testing in breaking seas which included evaluation of the effectiveness of drogues on liferafts, references 6 and 7. Their trials showed that the drogues "very often got entangled and did thus lose their effect." (reference 6). They deduced that it was the successive pulling and slackening of the line which caused the problem. To prevent this from happening, a net was fitted between the shroud lines at the forward end of the drogue. After this modification, it was found that the sea anchor never got entangled.

During the Coast Guard CWC tests, it was found that the very large parachute drogue did not become entangled. In fact, this drogue had such high drag that it would barely move as the arm rotated, thus the motion was absorbed in stretch of the towline and relatively high loads were generated.

The series drogue behaved well. When the towline went slack the weight on the end of the drogue sank, pulling the conical elements backward and taking up some, but not all, of the slack. This is a desirable characteristic. There was no tendency of the series drogue to reverse direction or foul.

Under storm conditions it would be desirable for the drogue to ride at least 20 to 30 feet below the surface so it would not be affected by local waves or caught by a breaking wave crest. The series drogue is held down by the anchor at the end of the line. In an effort to submerge the cone drogue a weight was added to the hoop. This did not appear to be a good solution because when the towline went slack the drogue rotated and collapsed.

The drag was measured at several flow velocities with the rotating arm in the fixed position. Then, with the arm rotating, the transient drag was recorded on a strip chart. Figure 9 lists some of the measured values of peak load.

3.3.4 Conclusions. After observing the various drogues in the water channel, it was apparent that a cone or a small parachute drogue will collapse when the towline goes slack, as will occur each time the boat passes through the trough of a large storm wave. This behavior results from the fact that the mass of water in the wake behind the drogue continues to move forward after the towline force has dropped to zero. This wake can collapse and even tumble the drogue.

There is a long history of drogue failures under storm conditions. It is probable that the alternative filling and collapsing is a major cause of these failures. In a single storm, a drogue can be subjected to as many as 10,000 cycles. The very large parachute drogue and series drogue do not behave

Drogue Type	Wave Amplitude (feet)	Wave Period (seconds)	Drift Velocity (ft/sec)	Measured Drag (lbs)	Computed Drag (lbs)
4.5-inch cone	0.50	1.08	1.5	0.44	0.41
2.6-inch cone	0.25	0.86	1.0	0.10	0.10
Series 14	0.50	1.08	1.5	0.46	0.48

FIGURE 9. Comparison of Measured and Computed Drogue Loads

in this manner; however, the small conical elements of the series drogue are subjected to some cyclic motions. A section of the full-scale series drogue was subjected to a fatigue test which will be discussed in a later section.

3.4 Hull Drag Determination

3.4.1 Introduction. An important objective of the program is to develop a reasonably accurate method of estimating the load imposed on a specific boat and drogue system by a breaking wave strike. From the tests reported in reference 1, it was determined that the drogue load was made up of three major components:

1. The inertia load as the boat is decelerated by the drogue.
2. The horizontal component of the buoyancy force when the boat is riding on the sloping wave face.
3. The hull drag force resulting from the boat being pulled through the fast-moving water of the breaking wave crest.

A diagram of these forces is shown on Figure 10.

The tests described in this section are specifically directed toward defining the hull drag during a breaking wave strike. The result will be used as input into a computer simulation of a boat/drogue system during a breaking wave strike. The computer program will be documented in a subsequent section of this report.

In a typical event, the boat will be pulled up to the wave crest by the drogue and then pulled through the moving water of the crest. For a wave with a wave length of 300 feet, the water in the breaking crest will be moving near wave phase speed or 39 ft/sec. Computer simulation indicates that a drogue may decelerate the boat to a speed of approximately 15 ft/sec. For a 30-foot boat with a water line length of 22 feet, this relative velocity of 24 ft/sec would represent a speed/length ratio (knots/ water line length) of 3, far above the hull speed. There are no published data on the drag of sailing yacht hulls in this speed range. Therefore these tests were run to obtain drag values to use in the computer simulation. Since the goal of the computer program is to predict gross loads and general behavior only, the accuracy sought in the drag measurements is on the order of $\pm 10\%$.

3.4.2 Test Equipment and Procedure. The tests were conducted in the Circulating Water Channel at the U.S. Coast Guard Academy at New London, Connecticut. This facility is described in reference 5 and provides a flow channel 2 ft deep by 4 ft wide by 12 ft long with a maximum flow velocity of 8 ft/sec.

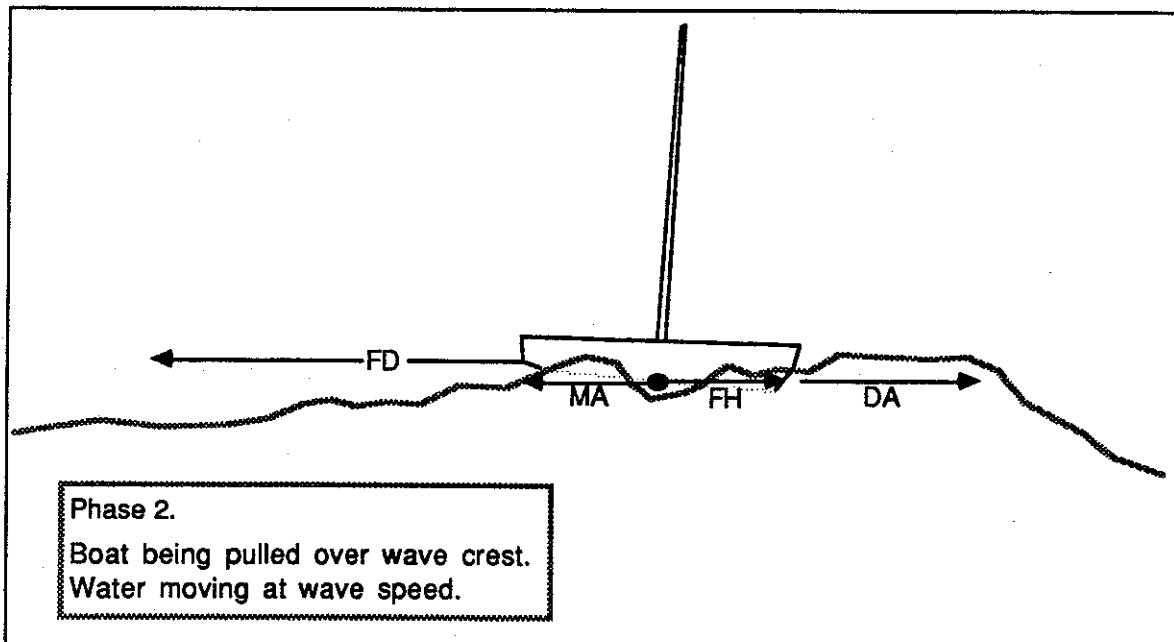
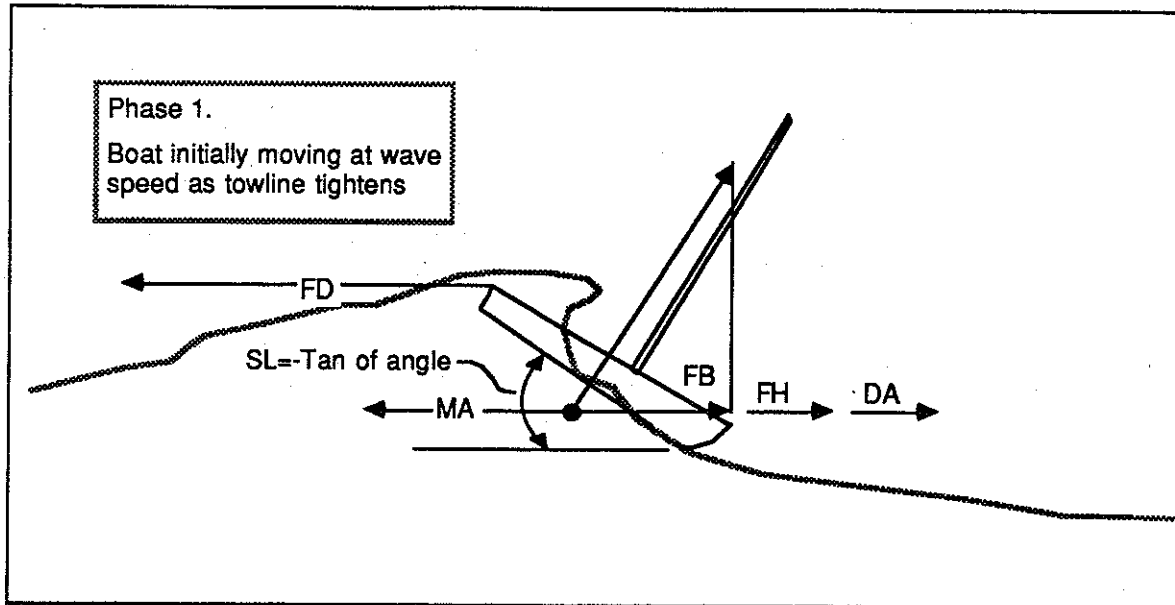

- FD — Drogue force
- MA — Inertia force
- FB — Horiz. comp. of buoyancy force
- FH — Hull drag force
- DA — Wind force
- SL — Slope of wave face

FIGURE 10. Forces During Wave Strike

Three monohull models were tested: a 1/43 scale model and a 1/32 scale model of the "Standfast" sailing yacht and a 3-foot fiberglass model purchased from Dumas Products, Tucson, Arizona. Their "Huson" design was modified to represent a 1/14 scale model of the "Standfast."

One trimaran model was tested. This did not represent a specific full-scale design but was intended to be typical of multihulls in the 30 to 40-foot size range. The characteristics of these models are listed in Figure 11.

For a typical test run, the model was placed in the flow channel and tethered to a load cell with a light monofilament line attached to either the bow or to the stern. This was done to simulate the boat being pulled forward, as with a sea anchor, or backward, as with a drogue. The velocity of the flow channel was varied from 2 to 8 ft/sec and the drag load recorded on a strip chart.

3.4.3 Test Results. A plot of drag against speed for each of the models is shown on Figures 12 and 13.

When towed from the bow, the monohull models often became unstable at high speeds and would yaw from one side of the channel to the other. The monohull models were generally stable when towed from the stern. The trimaran model was stable in both directions.

It was also noted that the monohull models developed more dynamic lift when towed from the stern and showed less tendency to "bury." A photograph of model No. 2 during testing is shown on Figure 14.

No attempt was made to correct for Reynolds Number effects since such refinement is unwarranted for this application.

3.4.4 Conclusions. The drag was about the same whether the models were towed backward or forward. The stability of the monohull models was better if the model was towed backwards.

The drag against speed curve showed a flat spot where the model started to plane. It is obvious that a hull shape more conducive to planing would have a much lower drag in this high-speed regime.

In the computer simulation of a breaking wave strike, the hull drag is defined by a term $RB = \text{Drag}/V^2$ where V is hull speed relative to the water. In order to obtain an approximate value of RB for a 30-foot boat, the test results for all the models were scaled up as shown on Figure 15. A value of $RB = 4.8$ provides a reasonable fit for the monohull models and

Design	Model 1 Huson (modified)	Model 2 Standfast	Model 3 Standfast	Model 4 Trimaran
Length (inches)	36	16.1	12	12
Weight (pounds)	7.5	0.66	0.27	0.12

FIGURE 11. Model Characteristics

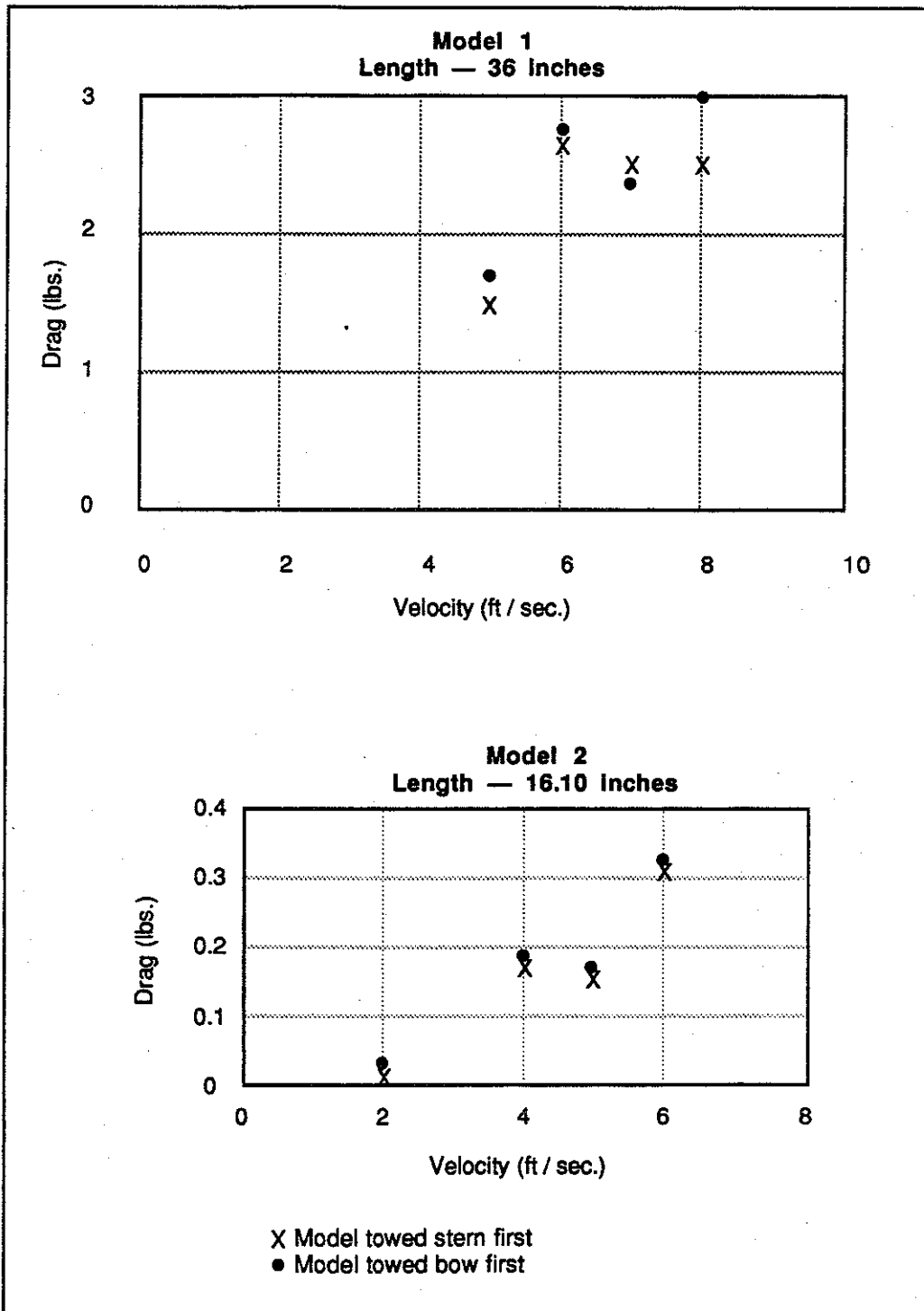

Figure 12. Model Hull Drag

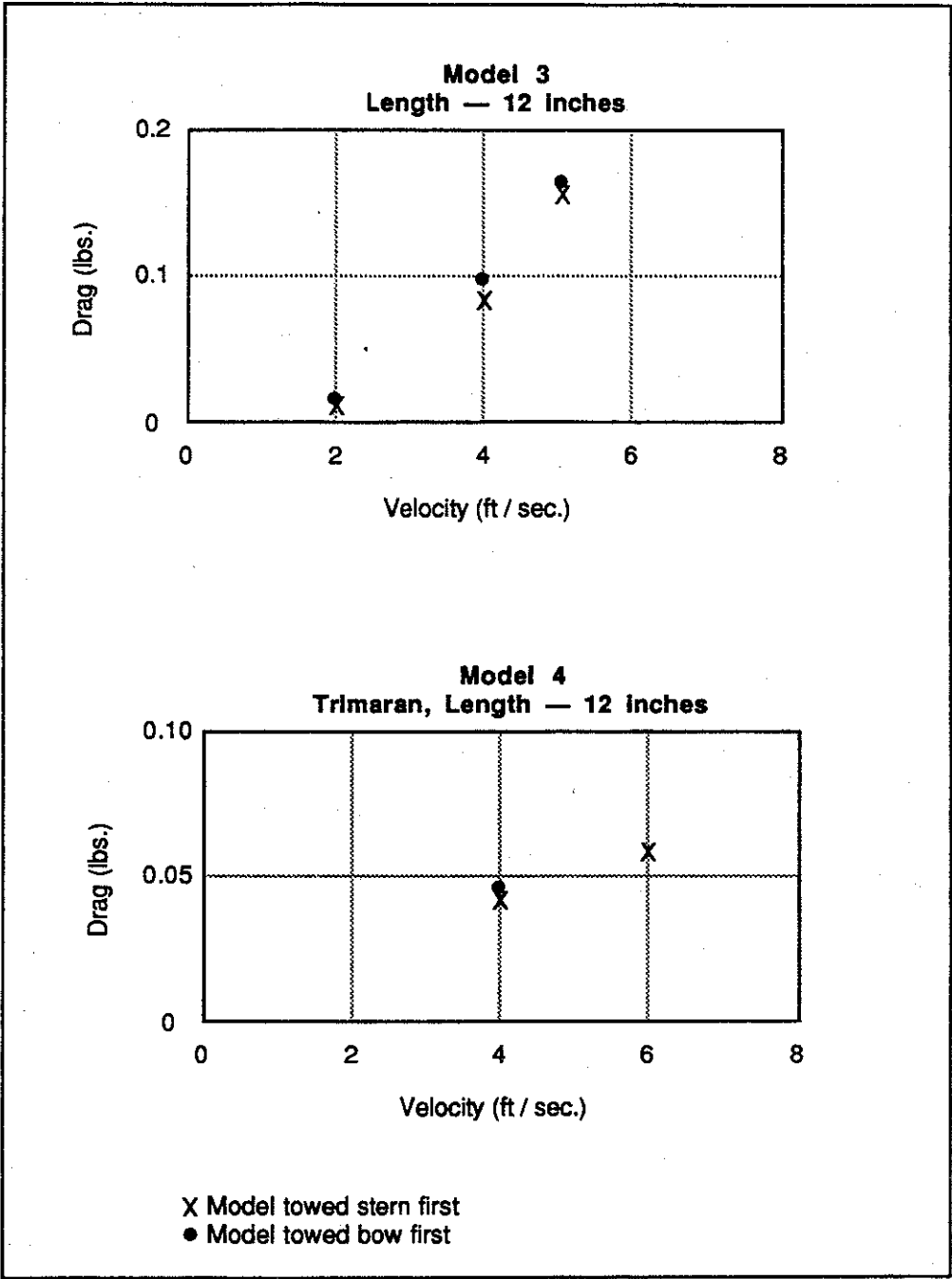

FIGURE 13. Model Hull Drag

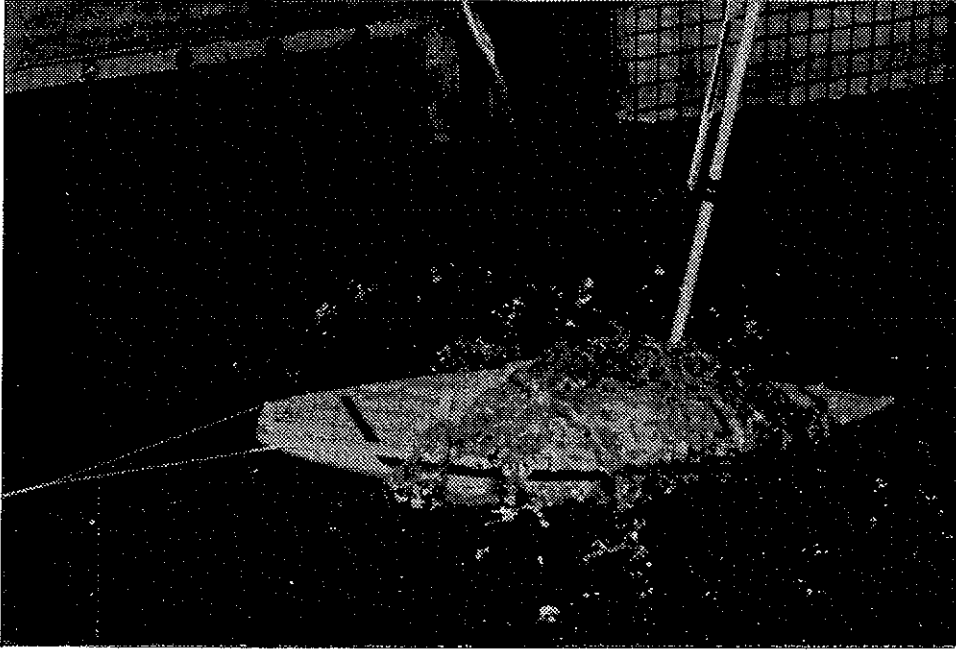
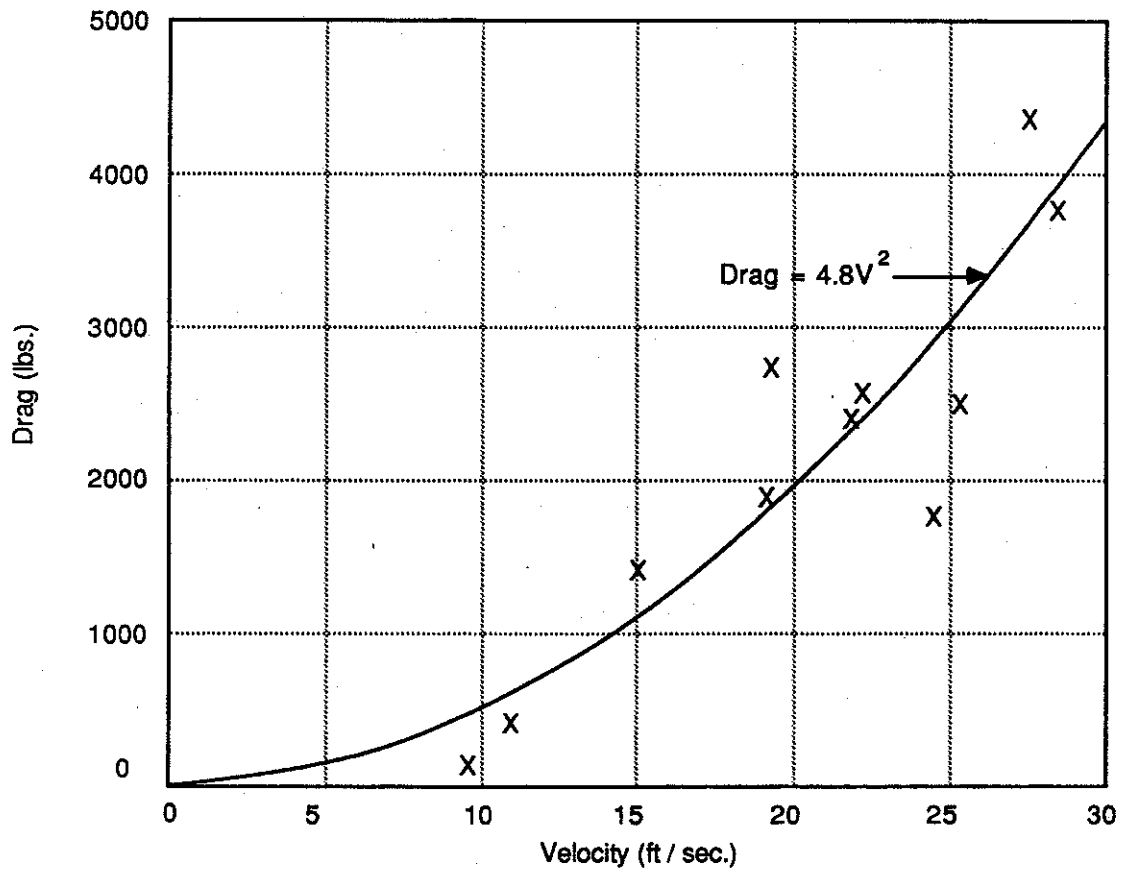

FIGURE 14. Model in Flow Channel



Note: All monohull drag values scaled up to 30 ft. L.O.A.
 Displacement 7500 lbs.
 Includes bow first and stern first

FIGURE 15. Full Scale Hull Drag

should be suitable for use in the computer simulation. The data may be scaled up to other boat sizes as required.

4.0 FULL-SCALE DROGUE TESTING

4.1 Drag Tests of a Series Drogue

4.1.1 Introduction. A new type of drogue called a series drogue has been developed as part of this research program. The objective of these tests was to measure the drag characteristics of a typical series drogue and to investigate the handling characteristics during deployment and retrieval.

The drogue which was tested is described by Figures 16, 17 and 18. It consisted of ninety 5-inch diameter conical elements spliced into 150 feet of line. A 35-lb cylindrical weight was attached to the end to keep the drogue submerged. The drogue was attached to the boat with 80 feet of line making the length of the entire assembly 230 feet.

4.1.2 Test Procedure. The drogue was towed by the 42-foot Coast Guard R&D research vessel. Drogue loads were measured by a Sensotec load cell with a maximum capacity of 10,000 lbs. Boat speed was measured using a "knotmeter" which was mounted on a support attached to the side of the boat. A knotmeter is a device which computes and displays speed as a function of the number of rotations of a propeller. Prior to the drogue tests, it was necessary to calibrate the knotmeter by timing a series of runs past a known fixed distance. Data from both the knotmeter and the load cell was recorded on a strip chart. Prior to the test the entire drogue was faked out in the cockpit and the end attached to the load cell. To deploy the drogue, the weight was dropped over the stern and the drogue fed out by hand as the boat proceeded at 2 to 3 knots. To retrieve the drogue, the boat was stopped and the drogue was pulled in by hand as slack developed from the motion of the boat on the waves. There was a 25 to 30 knot wind blowing at the time of the tests. Also, a significant tidal current was flowing at the test site. The wave height was approximately 3 feet and whitecaps were forming.

4.1.3 Test Results. A total of 9 runs were made as listed in Table 1. For runs 1, 2, 3, 8, and 9, the boat was run at constant power until conditions were stabilized, then the readings were taken. For runs 4, 5, 6, and 7 the boat was essentially stopped for several minutes until the drogue sank to a considerable depth. Then the engines were accelerated to a high rpm and held at that power until the first 10 to 20 elements of the drogue began to surface on the top of the water. For runs 8 and 9, a 75-foot length of the drogue, which included 45 elements, was removed. This left 45 drogue elements

The measured drag loads are shown on Table 1 and plotted on Figure 19. Since the boat was pitching and rolling, a

TABLE 1. Test Results

Run	Speed		Load ~ Max. / Avg			Remarks
	Volts	Ft/sec	Volts	Pounds	C_D^*	
1	0.11	4.8	0.2	200	0.7	Stabilized - One engine slow
2	0.14	6.2	0.39 / 0.30	390 / 300	0.83 / 0.64	Stabilized - One engine incr. RPM slightly
3	0.22	9.5	0.59 / 0.50	590 / 500	0.53 / 0.44	Stabilized - First ten cones surface
4	0.36	15.4	N.A.			Accel. from stop until drogue surfaces
5	0.38	16.3	1.6 / 1.2	1600 / 1200	0.49 / 0.37	Accel. from stop until drogue surfaces
6	0.45	19.2	2.8 / 2.1	2800 / 2100	0.61 / 0.46	Accel. from stop until drogue surfaces
7	0.45	19.2	2.3 / 1.7	2300 / 1700	0.50 / 0.37	Accel. from stop until drogue surfaces
8	0.10	4.4	0.2	200		Half of cones removed (45)
9	0.23	9.8	3.3	330	0.55	Half of cones removed (45)

C_D^* = Drag Coefficient based on 90 5-inch diameter circles or 12.3 square feet

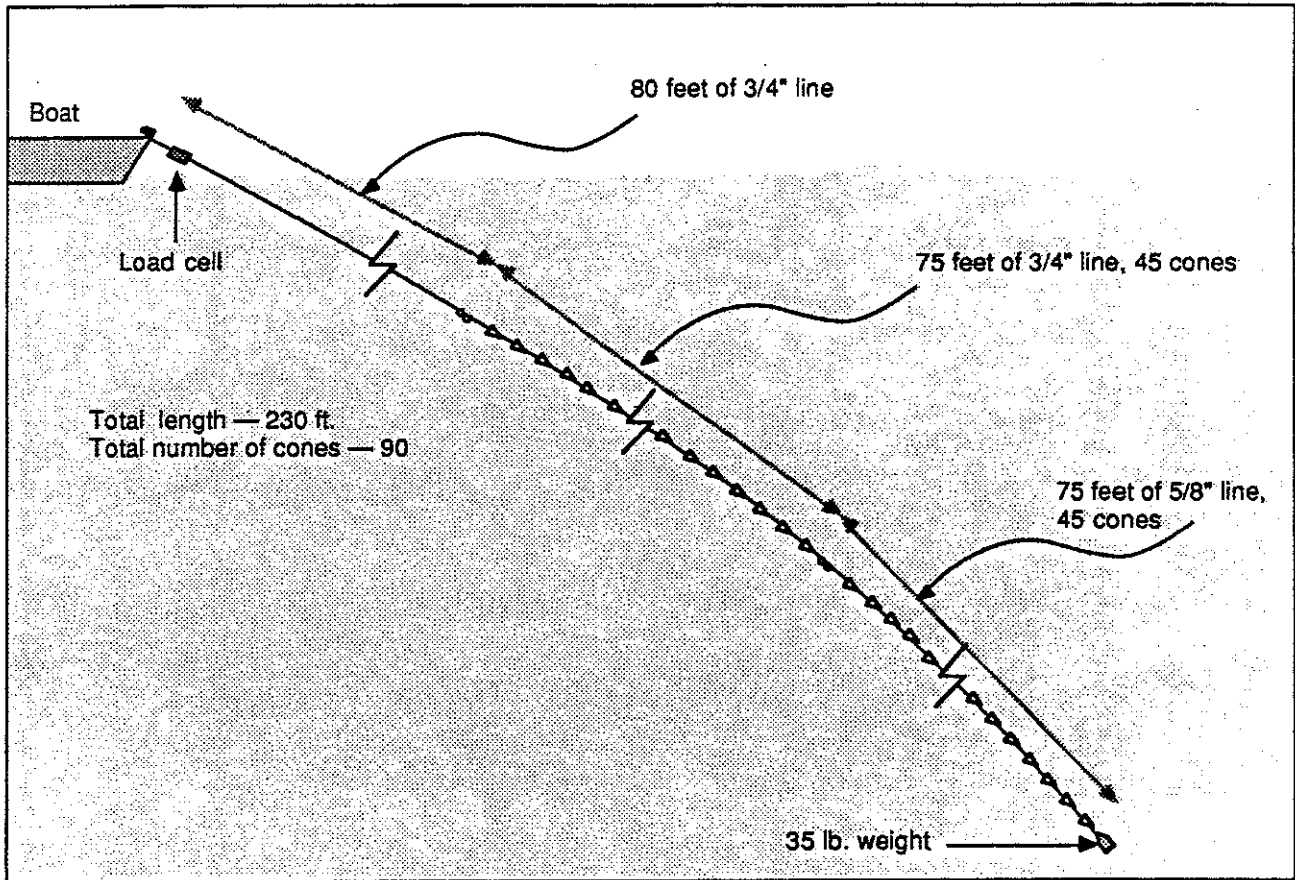

FIGURE 16. Series Drogue

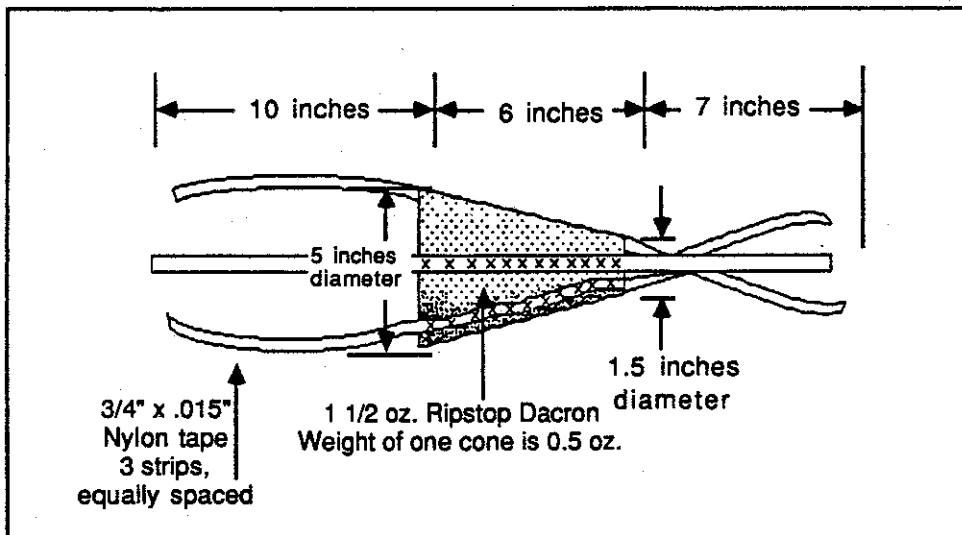
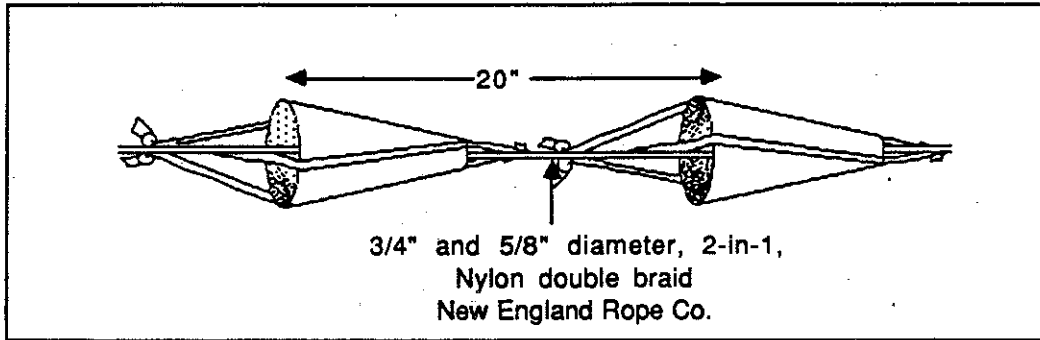

FIGURE 17. Series Drogue Construction

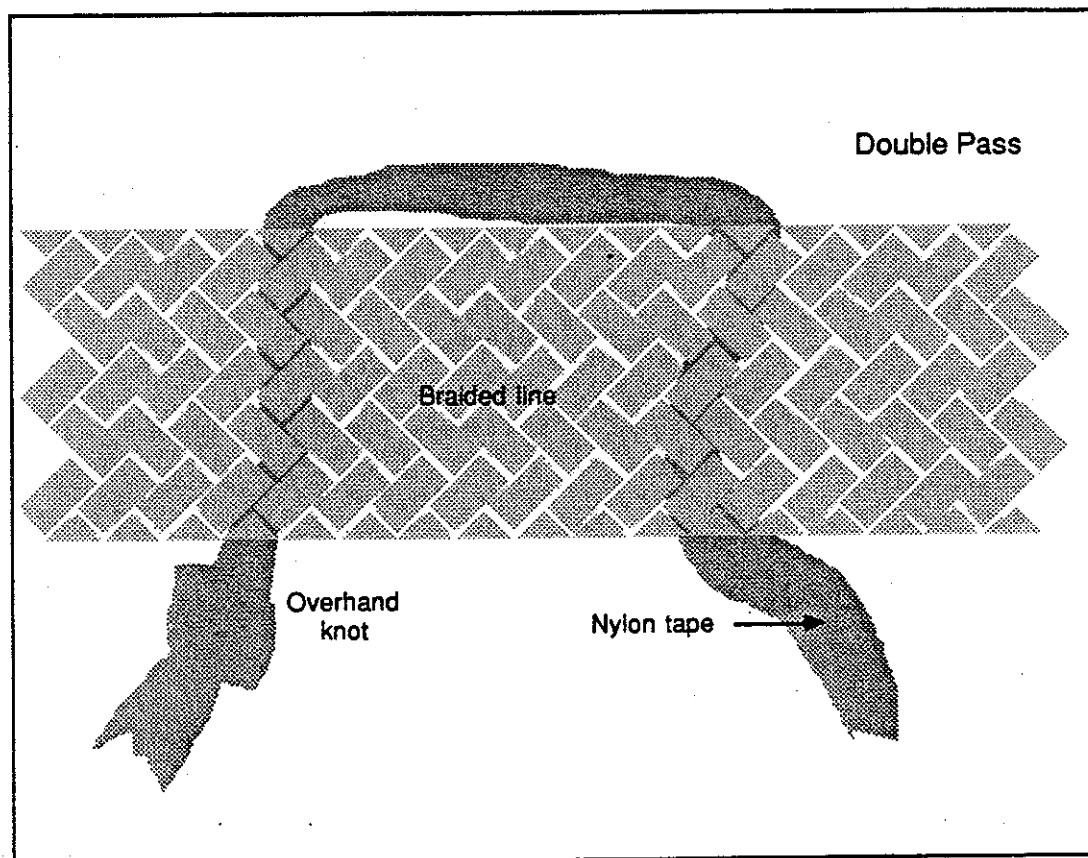
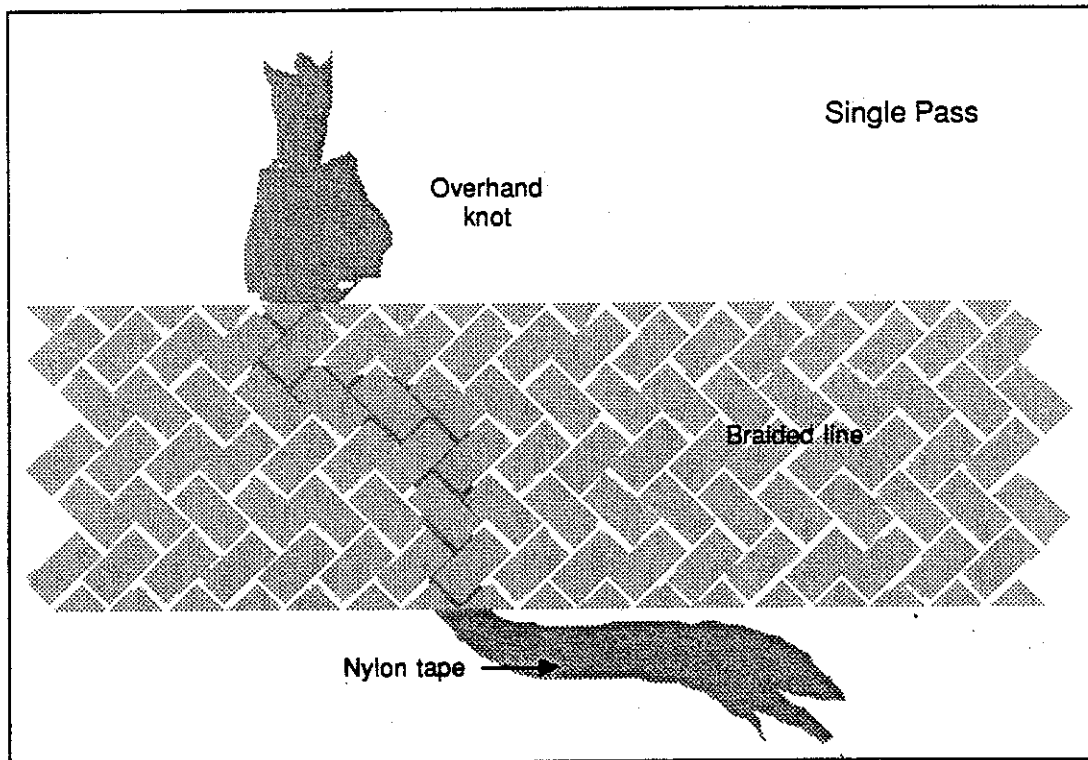

FIGURE 18. Splicing Methods

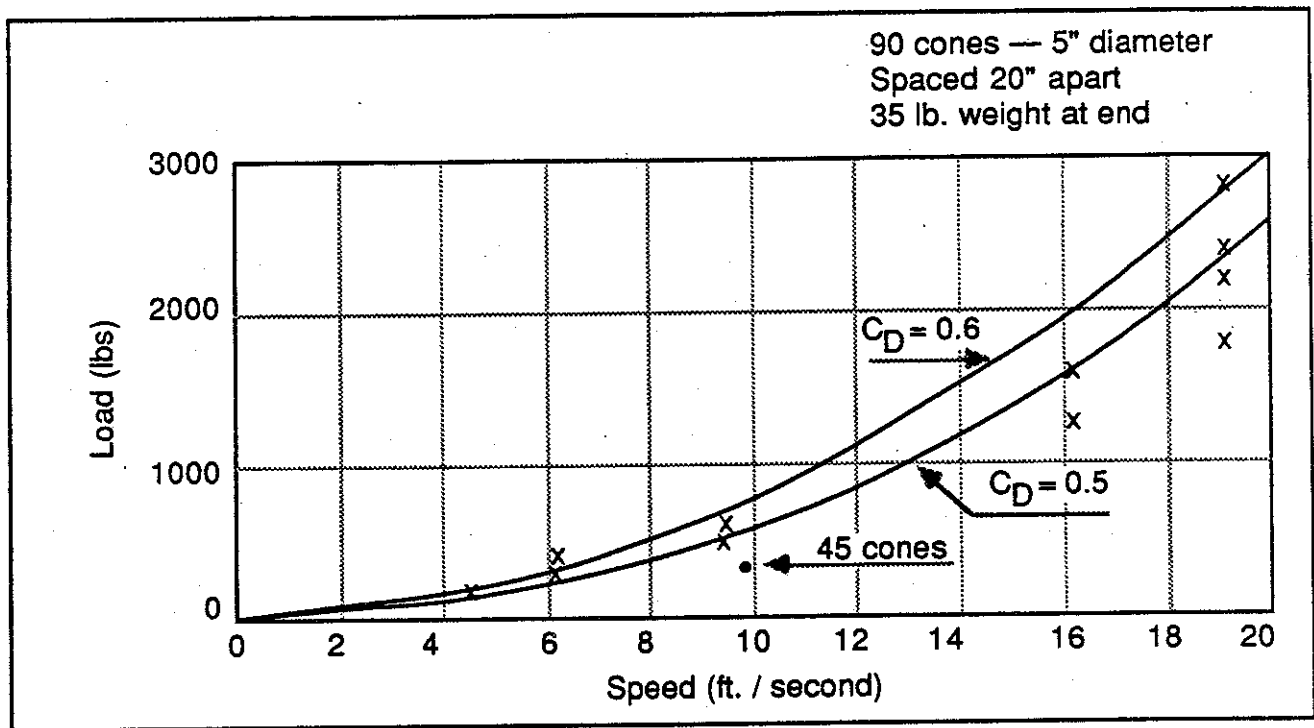

FIGURE 19. Drag of Series Drogue

maximum and average load is shown. Also in some instances the boat yawed and the drogue was not directly astern.

4.1.4 Conclusions. The drogue handled well throughout the test. No problems were encountered in deploying or retrieving the equipment and no deterioration or damage was noted after the tests. In the speed range where the drogue would normally operate (under 15 ft/sec), the average measured drag coefficient was 0.6 based on a drag area equivalent to ninety 5-inch diameter cones for a total of 12.3 square feet. For the acceleration runs, which are similar to a breaking wave strike, the drag coefficient was 0.6 or greater when the drogue first took up the load. As the speed continued to increase, the drag coefficient dropped to 0.5 or less as the drogue straightened and the first few elements began to pull out of the water. Based on this testing, it is considered reasonable to use a drag coefficient of 0.6 for estimating the drag of a series drogue.

4.2 Fatigue Tests of a Series Drogue

4.2.1 Introduction. Historically, the durability of drogues and sea anchors, when deployed under severe storm conditions, has been very poor. The equipment either breaks loose or tears apart after a relatively short exposure to heavy seas. Recent tests of model drogues in the circulating water channel at the U.S. Coast Guard Academy, Section 3.3 of this report, investigated the dynamic behavior of several drogue designs and provided an insight into the probable reason for the early failure of these devices in service. It was found that conventional cone and parachute type drogues alternately fill and collapse, sometimes reversing direction or tumbling. It is this violent motion which can cause structural failure.

A new type of drogue, called a series drogue, was developed as part of this program. A typical series drogue consists of ninety 5-inch diameter sailcloth cones spliced into a 150-foot nylon towline as shown on Figure 16. The end of the line is weighted with an anchor. Model tests, as previously discussed, showed that the series drogue would not foul or turn inside out under simulated storm conditions but the individual sailcloth cones would fill and collapse with the passage of each simulated wave.

The objective of the tests described in this report was to subject the series drogue to the same cyclic loads and motion that would be encountered in a major storm and to investigate the performance and durability.

4.2.2 Test Procedure. A computer simulation of a boat and drogue in 20-foot storm waves with a wave length of 200 feet indicates that the drogue will experience a cyclic velocity variation between 10 ft/sec in the direction of the wave to 2 ft/sec opposite the wave direction every 6 seconds. Thus, if the

storm lasts 10 hours, the drogue will be subjected to 6000 load cycles.

To simulate this type of service, a 5.5-foot section of a full-scale series drogue, which included three sailcloth cones, was mounted in the dynamic rope testing machine at the U.S. Coast Guard R&D Center, Groton, Connecticut. A schematic of the test sample is shown on Figure 17.

The rope testing machine is provided with a hydraulic ram with a maximum stroke of 36 inches and a maximum linear velocity of 2.5ft/sec. For this test, the ram was programmed to give a sinusoidal motion with an amplitude of 18 inches and a frequency of 0.3 cycles/sec. The motion of the ram was multiplied by a factor of 4 by a pulley system so that the test piece moved with a stroke of 6 feet and a peak velocity of 10 ft/sec. The ram pulled the test piece forward and a 5/8 inch diameter shock cord pulled it back. The sample drogue was submerged in a tank of water that was 17.5 feet long, 1 foot high, and 1.3 feet wide. A drawing of the test setup is shown on Figure 20.

The individual cones were made of 1.5 oz. rip stop Dacron sailcloth material in the flat with a single line of stitching and then turning the cone inside out. The three 3/4-inch nylon tapes were sewn to the cone material before the axial seam was fastened. The fore and aft edges of the cone material were left as cut, i.e., no tape or hem was applied.

Several methods of splicing the nylon tape to the 3/4-inch diameter braided line were investigated before the fatigue test. For this test two of the cones were attached with a double pass splice and one of the cones with a single pass splice. As shown on Figure 18, an overhand knot was tied in the free end of the tape to prevent it from pulling out.

4.2.3 Test Results. The test was run for a total of 15,000 cycles. The test sample performed normally throughout the test and no adjustment or repair was required.

Inspection of the three cones revealed the following:

1. There was no significant tearing or fraying of the cone material or the tape material.

2. The stitching was slightly loosened at the forward edge of the cone but gave no indication of pulling out.

3. None of the tapes pulled out or slipped in the splice to the 3/4-inch braided line.

4. At the conclusion of the test, the 1.5 oz. Dacron cone material was very soft and flexible. Apparently the filler material had worked out. The cones appeared to be

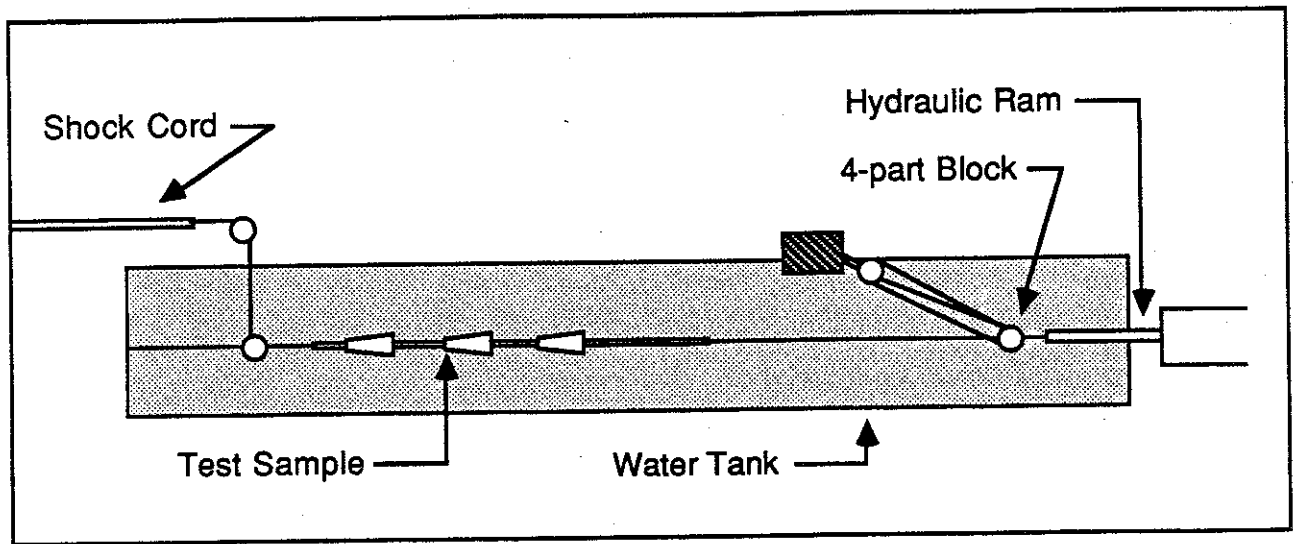

FIGURE 20. Fatigue Test Setup

somewhat stretched. However, this did not affect the functioning of the drogue.

4.2.4 Conclusions. This test clearly indicates that the durability of the series type drogue should be adequate for for prolonged operation under severe storm conditions.

The test sample was intended for use in drag tests, not durability tests. The cones were rather crudely sewn and it is both surprising and encouraging that they did so well.

It probably would be a good idea to sew a small reinforcing tape along the forward edge of each cone. This would reduce the possibility of tearing the material when retrieving the drogue over the transom of the boat.

4.3 Deployment and Retrieval Test of Series Drogue

On 1 October 1986 the R&DC conducted a test of the full-scale series drogue. The purpose of the test was to determine ease of drogue deployment and retrieval, note any hardware problems and determine how a sailboat rides with the drogue deployed from the bow and from the stern. The test was conducted under relatively calm conditions. The wind was N-NE (off land) at 15 knots with some gusts. There was a slight (6-12 inch) chop on the water. The tests were conducted between Ram Island and Fishers Island in 30-60 feet of water. There were 3 boats involved in the test, a 24-foot Dolphin with 4500 lbs displacement, a 28-foot Newport with 7000 lbs displacement, and a 21-foot motorboat which was used as a photo platform.

There were two drogues used, both based on the same design as shown on Figure 16, but one shorter than the other. The drogues each consist of 80 feet of lead line followed with 5-inch diameter drogue elements spliced into the line. The shorter drogue had 45 elements for a total length of 160 feet and had a 5 lb anchor attached to its end. The longer, full-scale drogue, had 90 elements, was 230 feet in length, and used a 20 lb anchor. The Dolphin crew deployed the shorter drogue while the Newport crew worked with the full-scale drogue.

The shorter drogue posed no problems in deployment. When deployed from the stern, the boat rode nicely, with \pm 10 degree yaw. When deployed from the bow, however, the boat was not held into the wind and eventually rode beam to the seas. Retrieval did not cause any problems, the drogue was hauled in hand-over-hand. This could prove difficult in windier conditions, and a winch or trip line may be necessary.

The Newport deployed the full-scale drogue easily. Initially, this boat behaved as the Dolphin, riding with \pm 10 degree yaw. Eventually the boat drifted into shallow water so that the drogue became anchored and entangled on the bottom. At this point, the drogue was brought aboard through the chocks and

some tearing of the elements occurred. This effort was then terminated.

Concluding, both drogues deployed easily. Even under difficult storm conditions, no major problems are anticipated. For these tests, the drogue was quite easily retrieved by hand. However, in storm conditions, it could be very difficult to get the drogue in. Therefore a properly sized winch located near the transom is recommended. A test under more severe conditions is required, and such a test is the subject of the next section.

4.4 Tests in Simulated Storm Seas

The ultimate proof of the drogue is, of course, using it in actual breaking sea conditions. Finding personnel, vessels, and instrumentation able to withstand the severe testing environment is neither safe nor practical. Nevertheless, it was desired to test in as large a sea condition as possible while maintaining a reasonable amount of control. The Coast Guard's National Motor Lifeboat (NLMB) School in Ilwaco, Washington, was considered one such place where a full-scale test could be conducted. The school is located at the mouth of the Columbia River and has a substantial sand bar running across the entrance, forming an area of significant surf. Because of the experience of the personnel at the NMLB School and the availability of their 44-foot motor lifeboats, it was decided to conduct our tests there.

Our test instrumentation consisted of a load cell capable of handling 10,000 lbs, a knotmeter to measure actual drogue speed through the water, a tape recorder, and both series and cone drogues. We tested in 12-14 foot waves with a 2-3 knot current. Some of the waves had breaking crests.

The water depth was 20-40 feet. This, obviously, did not represent deep ocean conditions. The shallow water influenced the actual drogue behavior in that under normal operating conditions the free end of the series drogue would have a 30-35 lb. weight attached. This allows all the drogue elements to lay fully underwater. For these tests it was not possible to weight the drogue sufficiently to keep all the elements underwater. During large pulls, the first 10 elements were pulled out of the water. This caused some secondary jerking on the load cell following the passing of a wave.

The results from the NMLB School testing were another verification of the use of a series drogue vs. a conventional type. The series drogue developed a maximum pull of 2500 lbs. Under the same conditions the cone drogue developed 2000 lbs. maximum pull. The boat rode better with the series drogue; there was not as large and sudden a jerk on the boat as it was pulled through the wave. Also, even though the cone drogue was deployed in the same wave conditions and was used for about 20 minutes less than the series drogue, it was destroyed at the end of the

test. The cone had turned inside-out and one of the longitudinal seams was completely torn.

The only problem noted with the series drogue is that it was difficult to retrieve at the end of the test. Under actual storm conditions, it is most likely that the drogue will be used through the entire storm and not pulled in until the waves and wind have subsided. During this test we were pulling against the waves. Also, it should be possible on many, if not most, larger sailing yachts to run the drogue through an aft winch which would make retrieval easier after the storm had passed.

Despite the fact that the test boat was heavier than what the drogues were designed for, they were held stern-to the waves. These tests, along with the previously described work, have shown the use of a stern-deployed drogue is a viable technique for stabilizing yachts in breaking seas.

5.0 MATHEMATICAL MODEL

5.1 Introduction

From photographs and reports of ocean storms we conclude that storm waves are generally not regular or stable, that is, each individual wave does not retain its shape for very long. The wind forces cause the wave crest to steepen until a white cap forms and takes energy from the wave. Often two or more waves intersect forming a complex pattern of wave additions and subtractions. The occasional dangerous breaking wave is a product of a random combination of a wave steepened by wind forces and a second wave which adds energy to the first.

In constructing a mathematical model it is obviously not feasible to consider the detailed interaction between a variety of boat types and a spectrum of wave types. However, it is possible to construct a generic model which permits us to study the significant engineering problems (as distinct from the scientific problems) associated with breaking wave capsizing.

The major engineering concerns are:

1. Construction of a theoretical framework to assist in interpretation of model tests and full-scale events.
2. Obtaining a working understanding of the relative importance of the factors involved in a breaking wave capsize.
3. Developing the capability to predict loads on the boat and drogue system with sufficient accuracy to permit rational design of the equipment.

Although this problem is extremely complex, the model tests show that much can be learned by the application of a relatively simple mathematical simulation. For this investigation the analysis was divided into two separate programs. First, a simulation of the boat and drogue in regular waves, and second, the boat and drogue being stuck by a breaking wave.

5.2 Boat and Drogue in Regular Waves

In a storm, the boat and drogue must ride for a long period of time in large non-breaking waves, possibly as high as 20 to 30 feet. There are many reports of the towline chafing and breaking or the drogue being ripped to pieces after several hours under these conditions. We are interested in understanding the cyclic motion of the boat and drogue, and the variation of load and slack in the towline.

Exploratory calculations were made using several mathematical models. The model finally chosen is shown on Figure 21. It is intended to represent a condition in which the wave length is much greater than the length of the boat; for example, a 30-foot boat riding on waves with a wave length of 200 feet or more. Experience suggests that this condition exists in all storms where there is a significant possibility of breaking wave capsize. Several simplifying assumptions can be made with this wave and boat geometry:

1. The buoyancy force is assumed to act normal to the wave surface at the boat location.
2. Pitching motion of the boat is neglected since the period of the wave is far greater than the natural period of the boat in pitch.
3. Since the drogue is far behind the boat the towline load is assumed to be horizontal. Vertical components of load are neglected.

A typical program is included in Appendix A for a boat riding on regular waves with a trochoidal-shaped profile. Similar programs were studied for waves with profiles of a sine wave, a cycloid, and certain arbitrary shapes intended to represent photographs of particular storm waves. Variation of boat displacement, drogue size and geometry and towline elasticity were also studied.

Figure 22 shows the drogue load and towline slack for a 30-foot boat with a 4-foot diameter parachute drogue in regular trochoidal waves with a wave length of 200 feet and wave heights of 10 and 20 feet. Figure 23 shows the same boat and drogue in

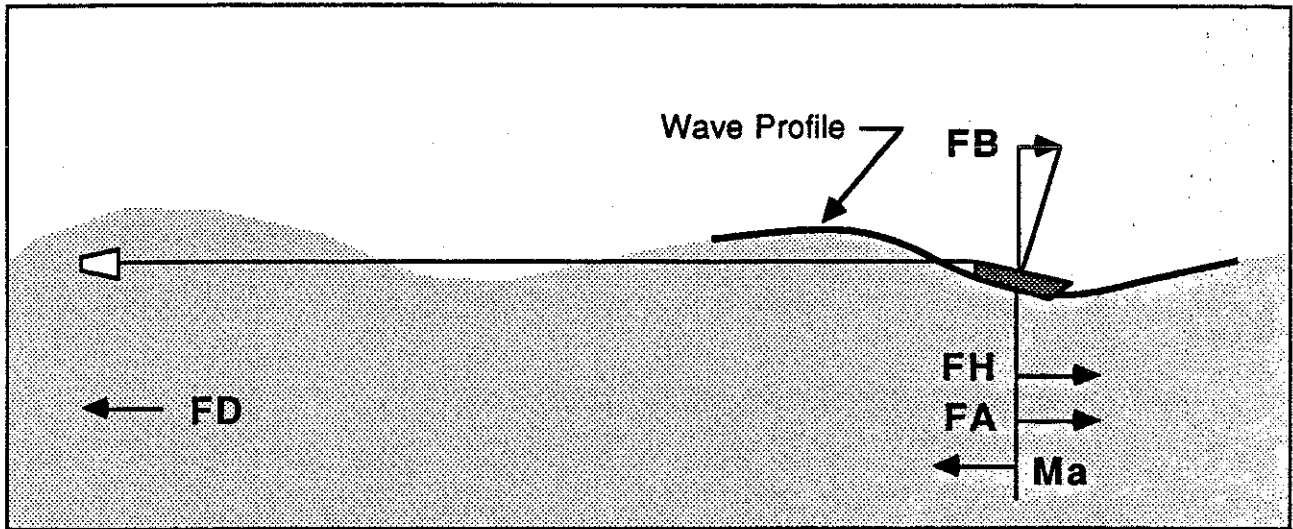

$$FD = \text{Drogue Force} = KK \times (X2-X1) = DD \times (V1)^2 + N a_1$$

KK = Towline Elasticity (lbs. / ft.)

(X2-X1) = Stretch in Towline (ft.)

DD = Drogue Drag Factor = Drag coefficient x area x ρ / 2

V1 = Drogue Velocity (ft. / sec.)

N = Effective Mass of Drogue

a_1 = Drogue Acceleration

$$FB = \text{Horizontal Buoyancy Force} = -(M \times G + M \times AV) \times SL$$

M = Mass of Boat

G = Acceleration of Gravity

AV = Vertical Acceleration of Boat

SL = Slope of Wave Surface

$$FH = \text{Hull Drag Force} = RB \times (VW-V2)^2 \times \text{SGN}(VW - VB)$$

RB = Hull Drag Factor = Drag coefficient x area x ρ / 2

VW = Velocity of Surface Water (ft. / sec.)

V2 = Boat Velocity

$$FA = \text{Air Force} = 0.6 \times DA + 0.4 \times DA \times Y / C$$

DA = Wind Force on Boat at Wave Crest (lbs.)

Y / C \cong 1.0 at Crest and -1.0 at Trough

$$Ma = \text{Inertia Force on Boat}$$

M = Mass of Boat

a = Acceleration of Boat

FIGURE 21. Forces on Boat / Drogue System

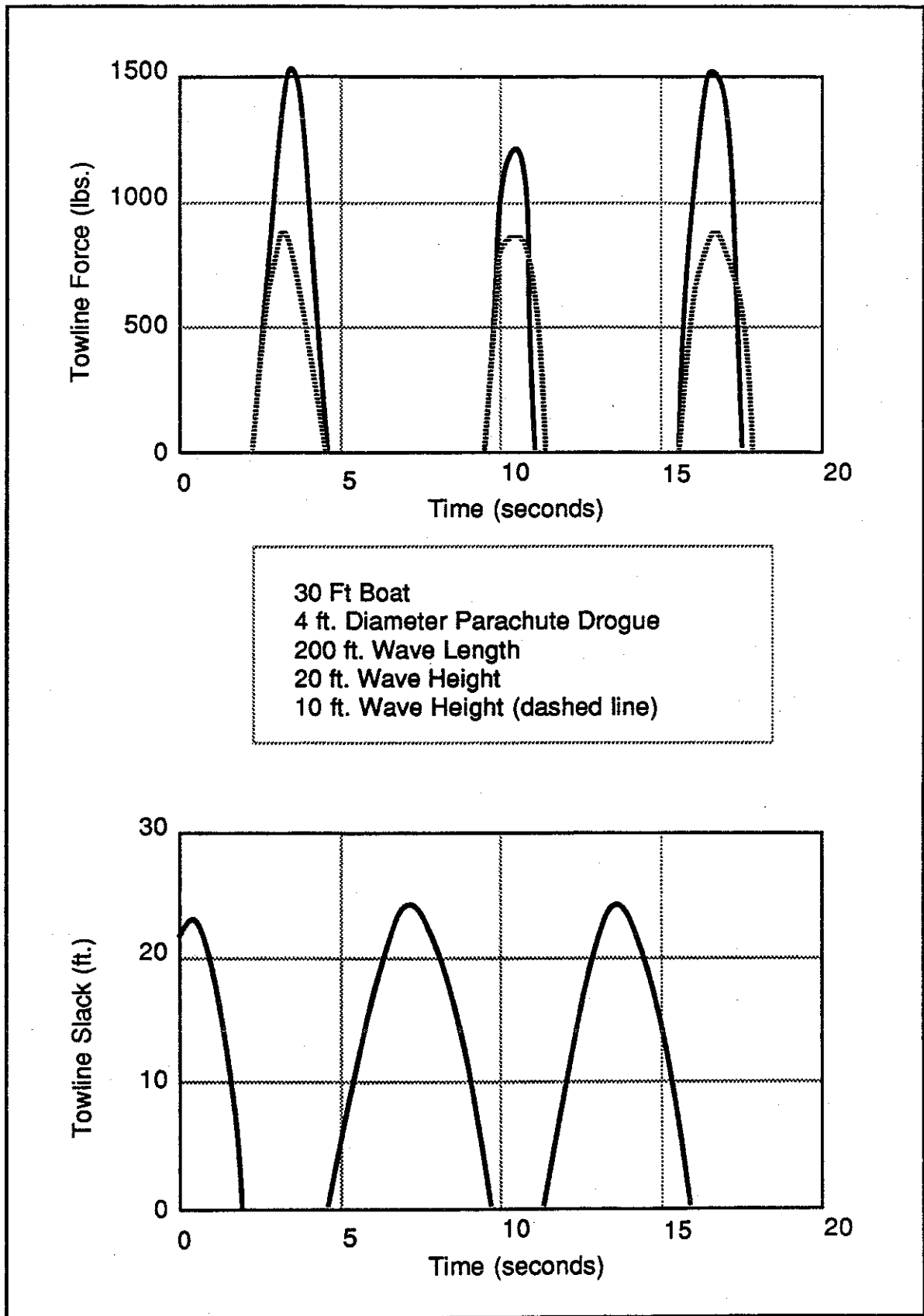

FIGURE 22. Computer Simulation — Boat and Drogue on 20-foot Waves

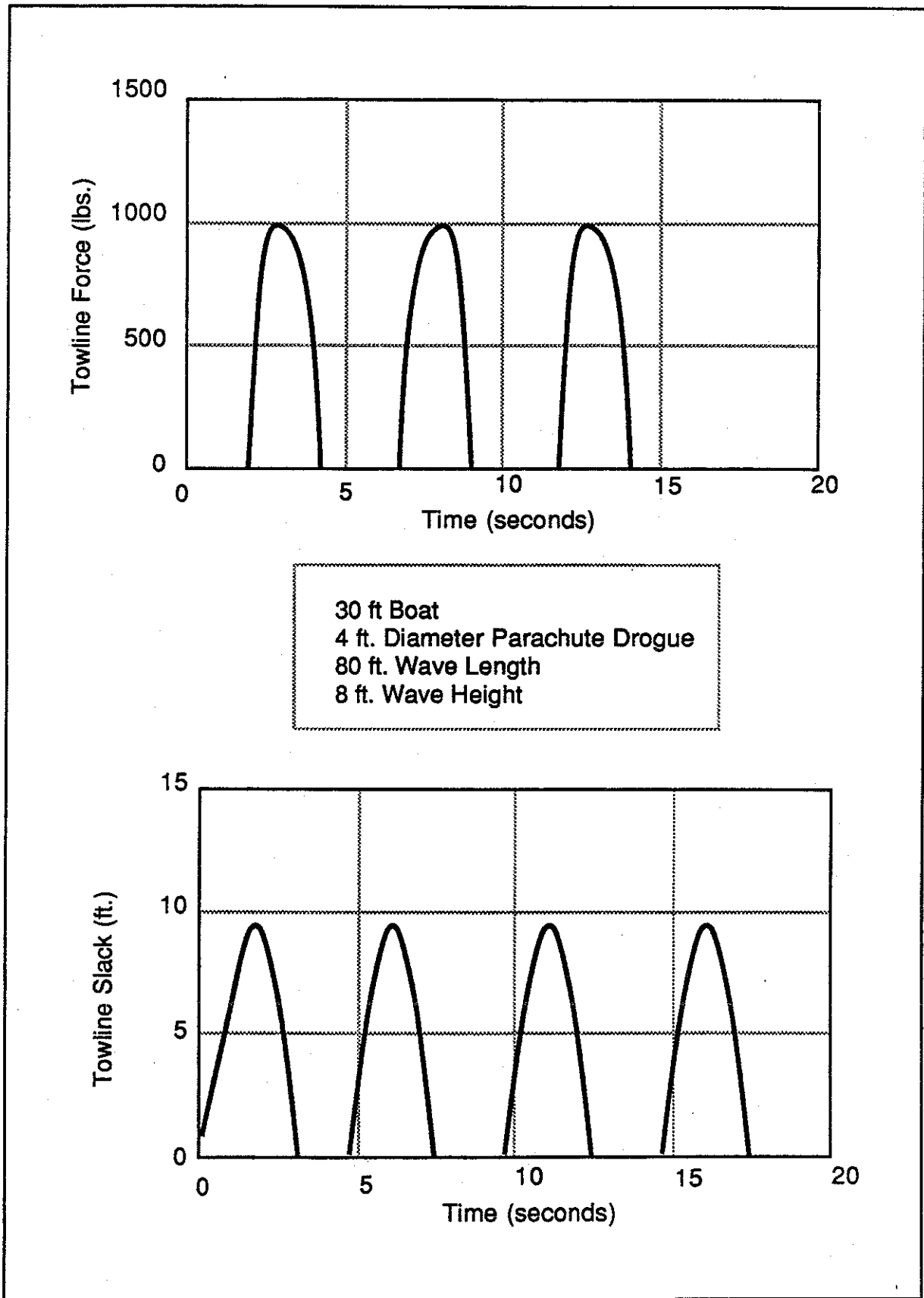

FIGURE 23. Computer Simulation — Boat and Drogue on 80-foot Waves

waves with a length of 80 feet and a height of 8 feet. The drogue exerts a load as the boat passes over the wave crest and the towline goes slack as the boat traverses the trough. Similar results are obtained with a variety of wave shapes. The peak load increases as we increase the boat displacement, drogue size, and stiffness of the towline.

No full-scale data are available to check the validity of this simulation, but sailors who have used drogues under storm conditions report that the peak loads did not appear to be high and the towline did not seem to go very slack. This suggests that there is more damping in the actual case than in the simulation, which makes sense because there are small surface waves superimposed on the large wave and these are not included in the simulation. Also in the actual case the waves are not regular and this would diminish the cyclic motion. It seems reasonable to conclude that the simulation could be considered a worst case, and the calculated cyclic loads could be used as design loads for fatigue strength and chafing resistance. Actual loads should be somewhat lower.

5.3 Breaking Wave Strike

The interaction between a breaking wave and a boat hull is a complex phenomenon. A mathematical model of this event is probably beyond current capability. However, what we are really interested in is obtaining a good estimate of the maximum load for use in designing the drogue and the attaching equipment. Fortunately the model tests have revealed a very important fact which permits us to greatly simplify this problem. The tests clearly show that whenever the boat is struck by a large breaking wave (large enough to cause capsize without a drogue) the boat is driven up to wave speed before the drogue builds up any appreciable load. Thus in estimating the maximum drogue load we can assume that the boat is moving at wave speed and calculate the force necessary to decelerate it. From the model tests we have determined which forces are important during the deceleration process. These forces are shown on Figure 10. There are two distinct phases. In the first phase, the boat is riding on the breaking crest and the drogue must pull it backward over the top of the wave. The important forces are the horizontal component of the buoyancy force (FB) and the inertia force (ma) as the boat is decelerated by the drogue. In the second phase the boat has been pulled over the top of the wave and is being dragged through the fast-moving water of the breaking wave crest. The important load during this phase is the hull drag force (FH). The relative speed between the boat and the water is several times the hull speed of a displacement hull, so the drag force will be high.

A simple breaking wave simulation using the forces shown on Figure 10 is included in Appendix B. It is assumed that the event begins with the boat riding the wave crest at a certain angle to the horizontal and moving at wave speed (V3). This phase continues until the boat is pulled through the wave crest for a specified distance. Then the boat is assumed to be essentially level at the top of the wave and is pulled by the drogue through water moving at wave speed. Wave height does not appear in this simulation but is represented by the assumption that the height is sufficient to drive the boat up to wave speed.

Model test results of drogue load against time were checked against this simulation. In general the correlation was acceptable. A typical comparison is discussed previously in this report. Although the simulation is highly simplified, it does logically represent the important forces and it should be highly useful in predicting maximum loads and in obtaining an understanding of the influence of various parameters on the maximum drogue load during a wave strike.

Figures 24A and 24B present calculated maximum drogue loads for a variety of conditions. As a reference for comparison purposes the following conditions were chosen:

- 30-foot boat, displacement 7500 lbs.
- 4-foot diameter parachute-type drogue
- 250 feet of 3/4-inch nylon towline (K=200 lbs/ft)
- 200-foot wave length
- 300 lbs. of wind drag
- Slope of boat on wave crest = 20 deg. (SL=-.36)

A breaking wave with a wave length of 200 feet will have a crest velocity of 32 ft/sec. Full-scale experience and model tests clearly show that such a wave can capsize a small sailing yacht. The breaking waves in the Fastnet storm may have been even of longer wave length but no actual data were obtained. A 4-foot diameter drogue was chosen as being near the minimum acceptable size for a 7500 lb. boat. The towline elasticity represents the dynamic behavior of 250 feet of 3/4-inch nylon double braid, the smallest line with adequate strength. The 20 degree slope of the boat when riding at wave speed on the wave crest is a reasonable value obtained from model test.

Figure 24A presents drogue load against time for the reference conditions. The load peaks at 5600 lbs or 75% of the displacement. This compares with a maximum load of 1500 lbs for the same boat and drogue riding on regular 20-foot waves with a length of 200 feet. As mentioned previously, it is felt that the 1500 lb. figure may be too high because more damping exists in the real case than in the simulation. However, there is no reason to believe that the 5600 lb. figure is too high.

Reference Case

30 ft. boat — Displacement 7500 lbs.
4 ft. diameter parachute-type drogue
200 ft. wave length
300 lb wind drag
Wave crest slope, 20 degrees

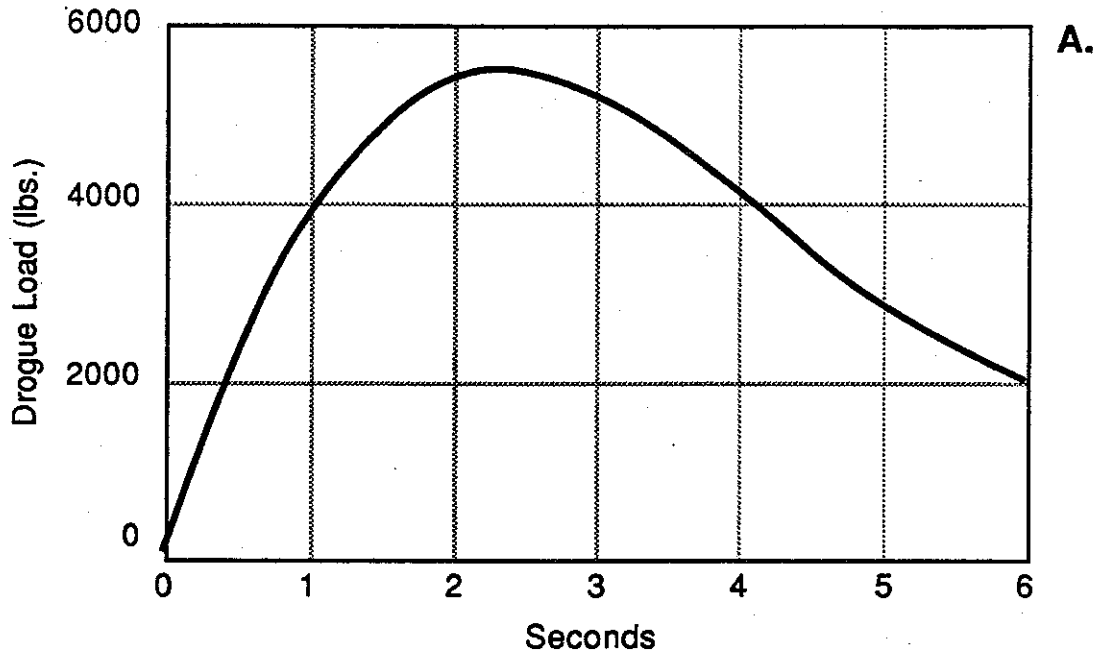

Effect of Size of Parachute Drogue

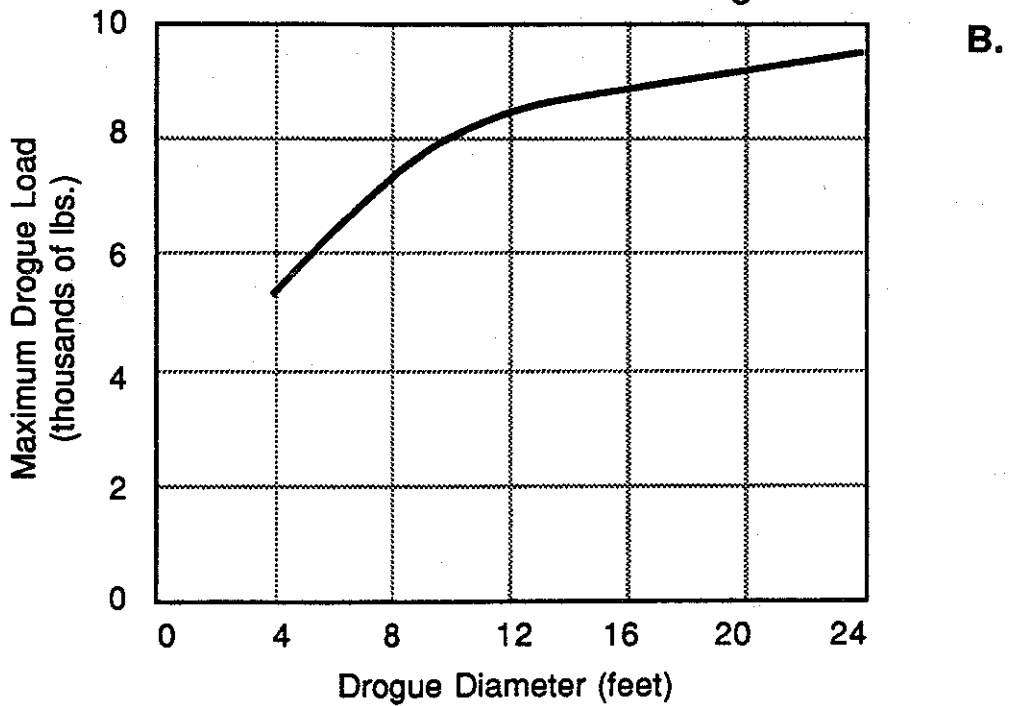

FIGURE 24.

Figure 24B shows the effect of drogue size on maximum load. Increasing the drogue diameter from 4 feet to 12 feet increases the load by 50%. It is clearly advisable to use the smallest drogue which will prevent capsize.

Figure 24C shows the effect of towline stiffness on maximum load. Some sailors believe that a highly elastic towline will reduce the drogue load. This may be true in regular non-breaking waves, but in a breaking wave strike the effect is small because the boat rides the wave front and stretches the line until the load builds up. Actually the model tests show that a highly elastic line is very undesirable because the boat may be capsized before the load builds up.

Figure 24D shows the effect of wave crest slope on the maximum drogue load. Referring to Figure 10, Phase 1, for a brief instant at the start of the event the boat is poised on the wave crest and is moving at the same speed as the wave. There is no significant vertical velocity or acceleration. The forward component of the buoyancy force is a function of the wave slope. This is a large force, equal to half the displacement at a slope of 27 deg. ($SL = -.5$). For the type of wave used in this investigation the model often reached a slope of 20 degrees before being pulled over the crest.

Figure 24E shows the effect of wave crest velocity on maximum drogue load. This is an important variable because the boat must be decelerated from this speed by the drogue, and both the inertia loads and the hull drag are a function of this velocity. Figure 24E also shows a scale for the wave length of regular waves which would correspond to a particular crest velocity. However, a breaking wave is formed by the addition of two or more storm waves. For a storm such as the Fastnet we have no information on the crest velocity of the dangerous breaking waves. It is reasonable to believe that the velocity would be no higher than that of waves with the longest length and probably would be somewhat lower.

An increase of crest velocity from 30 to 40 ft./sec. would increase the maximum drogue load by 35%.

Figure 24F shows the effect of boat size or displacement on drogue load. For this simulation it was assumed that all the pertinent variables were scaled up with boat size. The drogue diameter was scaled up as the boat length or as the cube root of the displacement. The hull drag factor, towline elasticity and wind force were also scaled up.

If the displacement is increased from 7500 lbs. (30-foot boat) to 30,000 lbs. (48-foot boat) the drogue load is increased by a factor of 3.4. Here we must make a judgement based on experience. The incidence of breaking wave capsizing

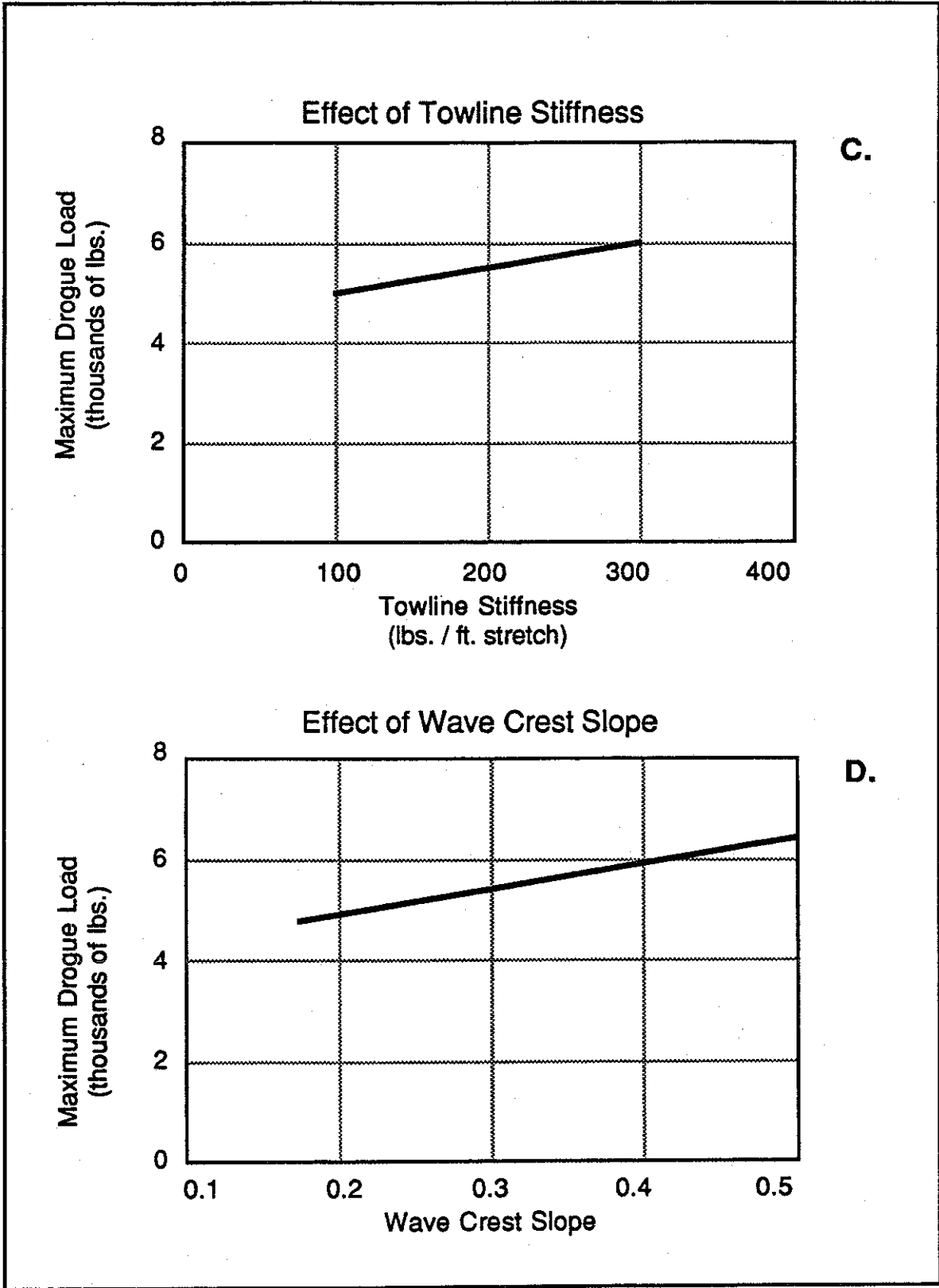

FIGURE 24.

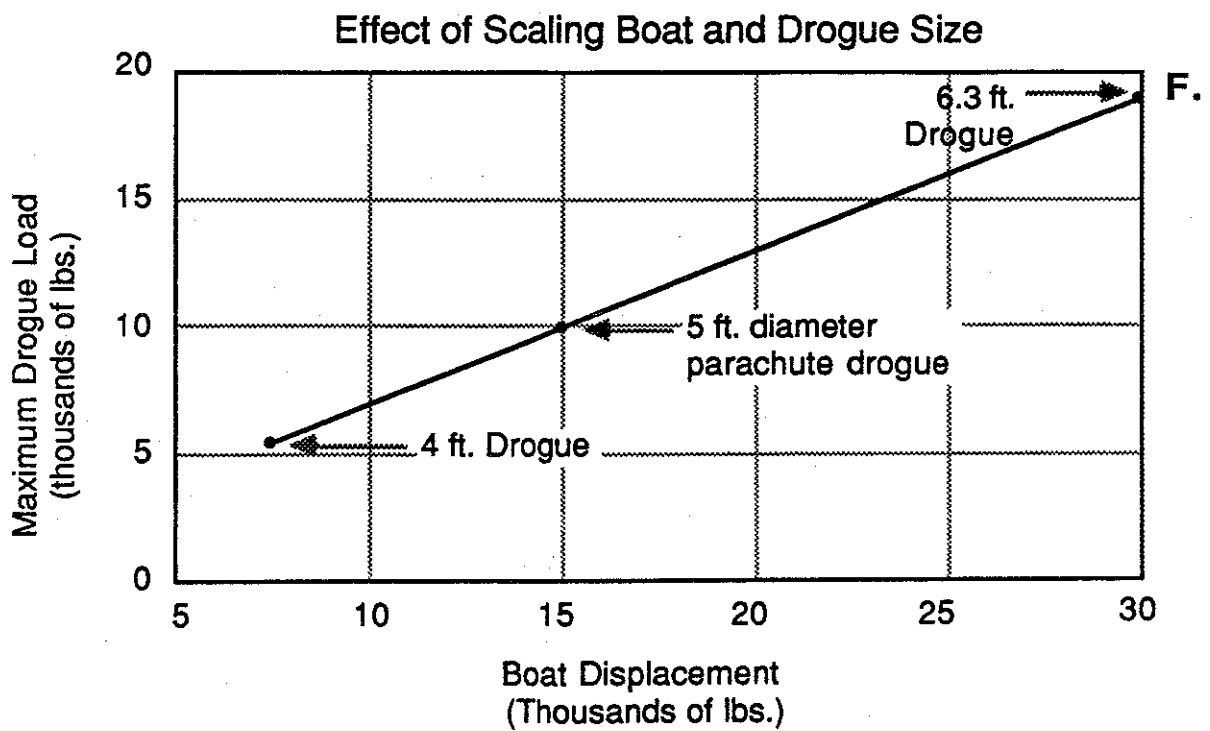
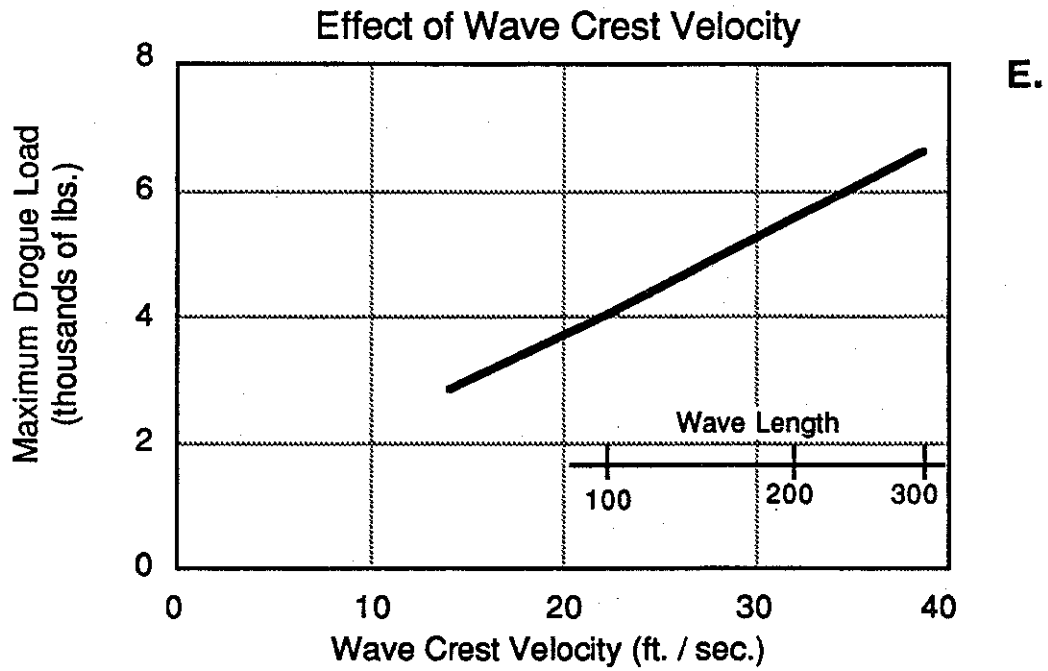

FIGURE 24.

decreases sharply with an increase in boat size or displacement. Many 30 to 40-foot boats have been capsized but very few boats over 60 feet have been capsized by a breaking wave. It is apparent that there are few breaking waves with enough momentum in the crest to drive a 60-foot boat up to wave speed. Thus in choosing a drogue size it is reasonable to decrease the relative size as displacement increases. With this policy the maximum drogue load need not increase as much as shown on Figure 24F.

6.0 RECOMMENDED DESIGN REQUIREMENTS FOR DROGUE SYSTEMS

As with other facets of marine engineering it is not feasible or perhaps even possible to design for the "ultimate wave" or the worst conceivable storm condition. It is necessary to use judgement based on experience such as the 1979 Fastnet storm, and to choose a set of design requirements which will adequately cover all but a few statistically improbable conditions.

The reasoning which led to the recommendations in this report is discussed below.

6.1 Drogue Size

The size of the drogue (the effective drag area) is the most important design decision. If the drogue is too small the boat will broach and capsize when struck by a breaking wave. If the drogue is large the maximum load will be high. Thus we wish to select the minimum size that will do the job. In the model testing reported in Reference 1, it was found that for a small sailing yacht with a displacement of 7500 lbs a cone or parachute drogue with a diameter of 4 feet or an equivalent series drogue would generally prevent capsize even when the model was struck by a very large breaking wave. Tests with a 2-foot diameter drogue showed the model to be capsized on approximately half of the wave strikes. With no drogue the model would be violently capsized on all the wave strikes. Based on these tests it was concluded that small sailing yachts require a drogue at least four feet in diameter or an equivalent drag device such as a series drogue.

The above discussion applies only to a drogue deployed for the stern. A sea anchor deployed from the bow would have to be much larger, 2 or 3 times the diameter of a stern drogue, in order to hold the bow into the wind and sea.

If a 30-foot boat displacing 7500 lbs needs a 4-foot diameter drogue, direct scaling would result in an 8-foot diameter drogue being required for a 60-foot boat displacing 60,000 lbs. However, the incidence of breaking wave capsize decreases rapidly with displacement and it is a rare occurrence for a yacht over 60 feet to be capsized by a breaking wave. It

is reasonable to believe that a drogue with a diameter less than 8 feet would be adequate for a 60,000 lb. boat. The drogue, however, should be large enough to prevent the boat from surfing down the face of a breaking wave and plunging into the preceding wave, an event that has been documented on a number of occasions. This criterion leads to the requirement of a 5.5-foot diameter drogue rather than an 8-foot diameter drogue for the 60-foot, 60,000 lb. boat. The calculations supporting this selection are presented in Appendix C.

Figure 25 presents a plot of the recommended drogue size vs. displacement for parachute and cone drogues and for equivalent series-type drogues.

6.2 Design Loads

The design load is the maximum load that will be imposed on the drogue, towline and attachments in the event of a very severe breaking wave strike. A load of this magnitude would be encountered rarely if at all, possibly once or twice in the lifetime of the equipment. To estimate the load it is necessary to assume a breaking wave crest velocity. A velocity of 39 ft/sec. corresponding to a wave length of 300 feet was used for this report. Such a breaking wave would be approximately 40 feet in height and is considered to be representative of the worst waves in the 1979 Fastnet storm.

Drogue loads were calculated using the computer program in Appendix B. Figure 26 shows the recommended design load plotted against displacement. It will be noted that at a displacement of 7500 lbs. the design load is equal to the displacement and at a displacement of 60,000 lbs the design load is 60% of the displacement.

6.3 Towline and Attachments

The drogue is deployed from the stern and attached to the boat with a bridle. The bridle performs two functions; it provides a turning moment to keep the boat stern to the wave, and it divides the total load and feeds the load into strong points at the corners of the transom. The attachments at each side of the transom should be designed to take 70% of the design load.

Figure 26 shows recommended towline diameter vs. displacement. Since this is a once or twice in a lifetime load, the diameters are based on 60 to 75% of the minimum breaking strength of double braid nylon line. The working load under storm conditions will be on the order of 10% of the minimum breaking strength and well within the fatigue limit.

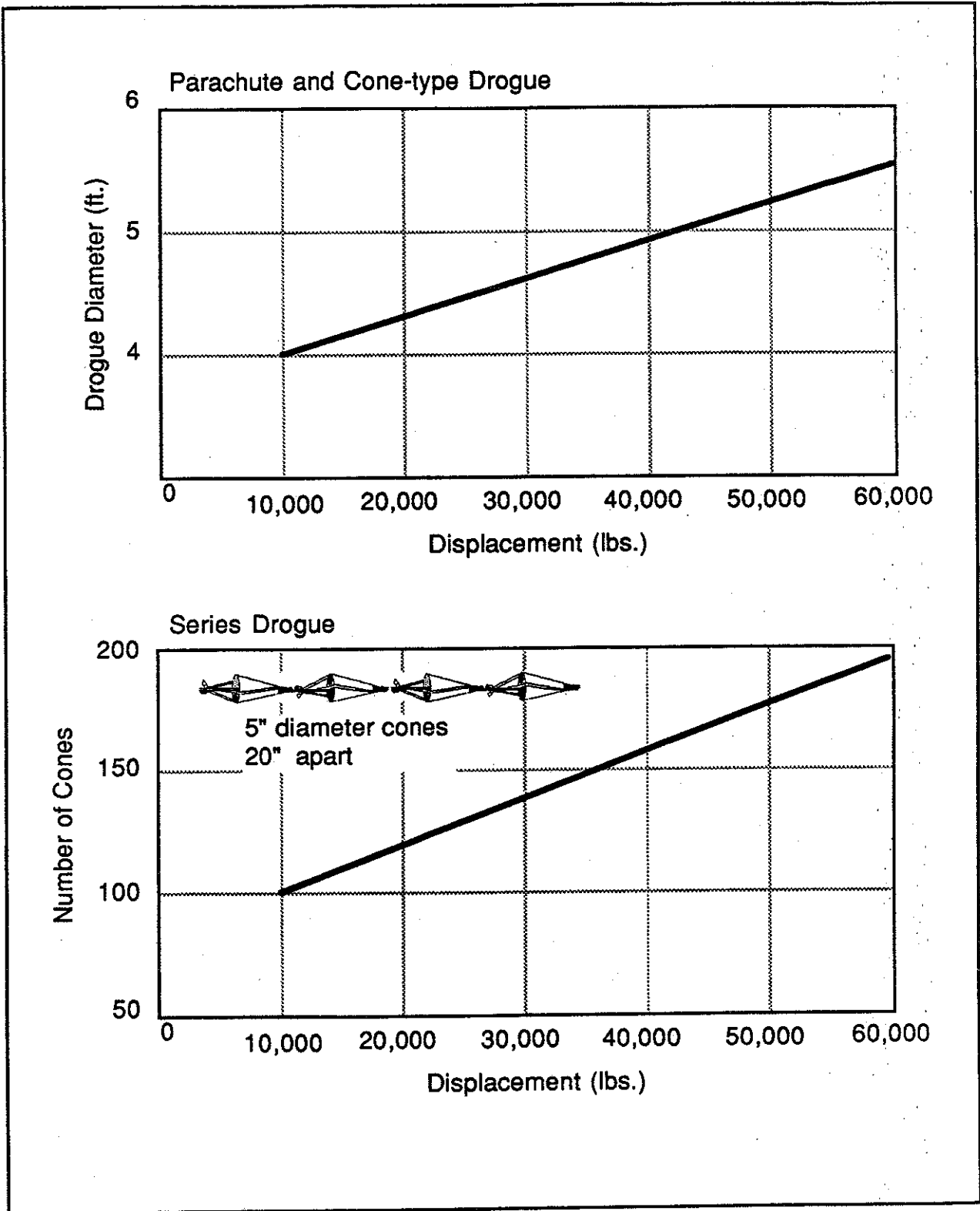

FIGURE 25. Recommended Drogue Size — Drogue Deployed from Stern

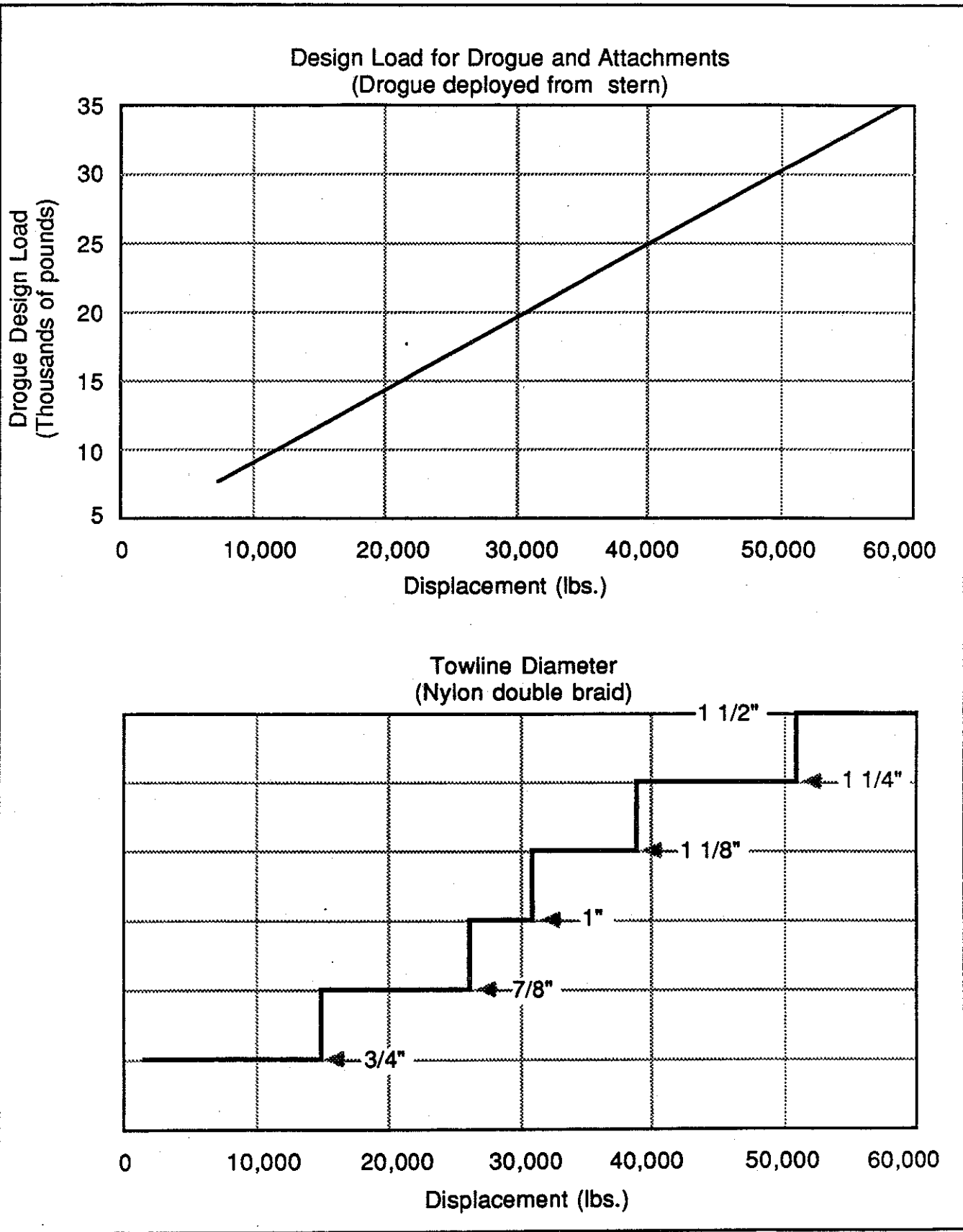

FIGURE 26. Towline Design Data

All elements of the equipment must be carefully selected. For example, the sheet metal thimble commonly used for an eye splice would not be adequate for this service. Reinforced thimbles are available and should be used. All shackles, eyes and swivels must be rated above the design load.

An anchor is used as a weight at the end of the towline. The type of anchor or the weight of the anchor is not critical. For smaller boats a 25 lb. anchor is adequate. For large boats a 35 to 50 lb. anchor is preferable.

The construction and attachment of the 5-inch diameter cones is shown on Figures 17 and 18. The 1-1/2 ounce rip stop dacron material is suitable for boats with a displacement under 30,000 lbs. Above this displacement, a heavier material is preferable.

6.4 Boat Design

With a drogue deployed, a well-designed and properly constructed fiberglass boat should be capable of riding through a Fastnet type storm with no structural damage. Model tests indicate that the loads on the hull and rigging in a breaking wave strike should not be excessive.

There are three areas that require special attention:

1. The attachment fittings for the bridle of the drogue towline at the corners of the transom must be capable of carrying 70% of the towline design load. For a 7500 lb. displacement boat each fitting must be capable of carrying 5300 lbs. Many yachts are equipped with a genoa track which runs aft to the transom. Such a structure, which distributes load along the hull, could be provided with a special eye at the transom for attaching the bridle.

If the nylon towline is led through a chock instead of attaching directly to an eye, experience suggests that chafing may occur even with good chafing gear installed. Consideration should be given to the use of a short length of wire cable running through a stainless steel chock before attaching to the nylon line.

2. Many sailors are reluctant to deploy a drogue from the stern because they fear that the boat may suffer structural damage if the breaking wave strikes the flat transom, the cockpit and the companionway doors. The model tests do not show this to be a serious problem. The boat is accelerated up to wave speed and the velocity of the breaking crest is not high relative to the boat. The stern is actually more buoyant than the bow, and will rise with the wave. However, the boat may be swept from the

stern. The cockpit may fill and moving water may strike the companionway doors. The structural strength of the transom, the cockpit floor and seat, and the companionway doors should be checked at a loading corresponding to a water jet velocity of approximately 15 ft./sec.

3. When a boat is riding to a drogue no action is required of the crew. The cockpit may not be habitable and the crew should remain in the cabin with the companionway closed. In a severe wave strike the linear and angular acceleration of the boat may be high. Safety straps designed for a load of at least 4g should be provided for crew restraint. All heavy objects in the cabin should be firmly secured for negative accelerations and drawers and lockers should be provided with latches or ties which will not open even with significant distortion of the hull structure.

6.5 Types of Drogues

The two conventional drogue configurations are the cone drogue and the parachute drogue. Both types have been used successfully in a variety of applications. A third type of drogue called a series drogue has been developed as part of this investigation. The series drogue is intended to provide near optimum performance under storm conditions and to avoid some of the problems encountered with cone and parachute drogues.

The series drogue offers the following desirable features:

1. If pre-rigged and coiled down in the lazaret, the drogue is simple and safe to deploy under difficult storm conditions. The boat, under bare poles, will be either running off or lying ahull. The anchor can be slipped over the stern and the line payed out. The drogue will build up load gradually as it feeds out.

2. It is almost impossible to foul it or entangle it enough to make the drogue ineffective.

3. The drogue rides beneath the waves and is not affected by the following sea even if a wave should break in the vicinity. There are cases on record where a cone drogue has been pulled out of the face of a following wave, and even instances where the drogue has been catapulted ahead of the boat. It is difficult to weight a cone or parachute drogue so that it will ride at a sufficient depth to avoid the wave motion. As discussed previously in this report, a weight causes the drogue to collapse when the towline goes slack.

4. When the boat is in the trough of a large wave, the towline tends to go slack thus permitting the boat to yaw. With the series drogue, the anchor sinks pulling the drogue backwards and taking some of the unwanted slack out of the towline.

5. When a breaking wave strikes, the drogue must catch the boat quickly to prevent a broach. The series drogue, since some of the cones are near the boat where towline stretch is low, will build up load faster than a conventional cone or chute at the end of the towline. A computer study shows that two seconds after wave strike, the series drogue will develop 40% more load than an equivalent cone or chute. Similarly, if the breaking wave strikes at an angle to the towline rather than directly astern, the series drogue will build up load much faster than the conventional types.

6. The series drogue is durable as demonstrated by the testing described in this report. The load on each individual element is low. No single failure can make the drogue ineffective.

7. The series drogue can double in function as a spare anchor line and can use the boat's regular anchor as a weight. All 90 cones weigh only four pounds.

6.6 Sea Anchor Deployed from the Bow

The foregoing recommendations and discussion apply to a drogue deployed from the stern rather than a sea anchor deployed from the bow. A large sea anchor would be required to hold the bow of a modern yacht into the wind and sea in a survival storm. The required diameter of the cone or chute would be 2 or 3 times the diameter shown on Figure 25. The design load would be 50 to 100% greater than that shown on Figure 26. Even with a large sea anchor the bow of a modern yacht will tend to yaw away from the wind when the towline goes slack as it will when the boat passes through the trough of the wave. For these reasons the use of a sea anchor deployed from the bow is not recommended.

7.0 CONCLUSIONS

This paper documents the investigation of the use of drogues to prevent small sailing yacht capsize in breaking seas. The following conclusions were reached:

1. In many and possibly most cases, a properly engineered drogue can prevent breaking wave capsizing.

2. For fin keel sailing yachts the drogue should be deployed from the stern, not the bow.

3. A series type drogue provides significant advantages over a cone or parachute type drogue.

4. A full-scale series drogue demonstrated satisfactory handling and durability characteristics under simulated storm conditions and in actual breaking wave conditions.

5.A recommended design specification including design loads is presented for cone, parachute and series type drogues.

There are no patents or proprietary information associated with the series drogue. It is hoped that some sailors who venture offshore will construct a series drogue using the recommendations contained in this report. As experience and knowledge are gained, this device could become part of the standard safety gear used on yachts. Preventing capsizes, and its subsequent damage to the boat and potential loss of life, will be the ultimate benefit.

REFERENCES

1. Jordan, D.J., "Investigation of the Use of Drogues to Improve the Safety of Sailing Yachts and Life Rafts," U.S. Coast Guard Report No. CG-D-37-84, December 1984.
2. Claughton, A. and Handley, P., "An Investigation into the Stability of Sailing Yachts in Large Breaking Waves," University of Southampton, Dept. of Ship Science Report No. 15, January 1984.
3. Stephens, Olin J., K.L. Kirkman, and R.S. Peterson, "Sailing Yacht Capsizing," SNAME, Chesapeake Sailing Yacht Symposium, pp. 37-58,, 17 January 1981.
4. "Safety from Capsizing," Report from the Directors, USYRU and SNAME, June 1985.
5. Colburn, W., W. Simpson, and V. Phelps, "The U.S. Coast Guard Academy Circulating Water Channel," Marine Technology, Vol. 18, No. 3, 1981.
6. Siglingamal, The Icelandic Directorate of Shipping, No. 12, December 1980.
7. Siglingamal, The Icelandic Directorate of Shipping, No. 13, July 1981.

APPENDIX A
LIST OF SYMBOLS

See Figure 21 for Force Symbols

X1	Drogue position
V1	Drogue velocity
X2	Boat position
V2	Boat velocity
L	Wave length
C	Half wave height
R	Wave circular frequency, rad./sec.
V3	Wave speed
Y	Wave height
SL	Wave slope
CL	Length of breaking wave crest

APPENDIX A

```

1 REM   BOAT AND DROGUE RIDING REGULAR TROCHOIDAL WAVE 12/21/86
5 OPEN #1:"PID"
6 PRINT #1:"BOAT AND DROGUE ON REGULAR TROCHOIDAL WAVE 12/21/86"
7 PRINT #1:"T";TAB(10);"Y";TAB(20);"V2";TAB(30);"X1-X2";TAB(45);"FD";TAB(55);"V1
"
10 X1=1
20 V1=8
30 X2=2
40 V2=8
50 L=200
60 C=10
70 R=14.2/SQR(L)
80 V3=L*R/6.28
90 M=233
110 RB=4.8
115 DA=300
120 DD=12.6
130 K=200
140 N=25
150 G=32.2
160 E=2*3.14/L
180 H=.01
190 FOR T=0 TO 50 STEP H
193 X1=X1+H*V1
196 X2=X2+H*V2
200 Y=E*C^2/2+C*CODS(E*X2-R*T)+E*C^2/2*CODS(2*(E*X2-R*T))+3/8*E^2*C^3*CODS(3*(E*X2-
R*T))
210 PSL=SL
220 SL=-C*E*SIN(E*X2-R*T)-C^2*E^2*SIN(2*(E*X2-R*T))-9/8*C^3*E^3*SIN(3*(E*X2-R*T)
)
222 AV=((V3-V2)*-SL-(V3-PV2)*-PSL)/H
230 VW=R*Y
235 FA=.6*DA+.4*DA*Y/C
240 FB=-M*(G+AV)*SL
250 FD=KK*(X2-X1)
260 FH=RB*(VW-V2)^2*SGN(VW-V2)
300 V1=V1+H*(FD-DD*V1^2)/N
310 PV2=V2
330 V2=V2+H*(FB+FA+FH-FD)/M
350 IF X2<X1 THEN 420
360 KK=K
370 IF 2*T<>INT(2*T) THEN 410
372 PRINT "T=";T
390 PRINT #1:T;TAB(10);INT(Y);TAB(20);INT(V2);TAB(30);INT(X2-X1);TAB(45);INT(FD)
;TAB(55);INT(V1)
410 NEXT T
420 KK=0
430 GO TO 370

```

APPENDIX B

5 REM DEC.31,1986, BREAKING WAVE STRIKE

```

10 OPEN #1:"PIO"
12 PRINT #1:"BREAKING WAVE STRIKE, 12/31/86"
13 PRINT #1:"X1=0_";"L=200_";"K=200_";"RB=4.8_";"DD=12.6_";"DA=300_";"M=233_";"S
L=-.36"
15 PRINT #1:"T";TAB(7);"FD";TAB(20);"V2";TAB(30);"V1";TAB(40);"CL";TAB(50);"FH";
TAB(60);"FB"
20 X1=0
30 V1=0
40 X2=0
43 L=200
45 V3=2.26*SQR(L)
50 V2=V3
60 K=200
70 RB=4.8
80 DD=12.6
85 DA=300
90 SL=-.36
100 M=233
110 G=32.2
140 H=.01
150 FOR T=0 TO 8 STEP H
160 X1=X1+H*V1
170 X2=X2+H*V2
180 FD=K*(X2-X1)
190 FH=RB*(V3-V2)^2*SGN(V3-V2)
200 FB=-M*G*SL
202 CL=(V3*T)-X2
204 IF CL>30 THEN 470
210 V1=SQR(FD/DD)
220 V2=V2+H*(FB+FH+DA-FD)/M
221 IF V2>V3 THEN 490
222 IF 4*T<>INT(4*T) THEN 390
270 PRINT "T=";T
330 PRINT #1:T;TAB(7);INT(FD);TAB(20);INT(V2);TAB(30);INT(V1);TAB(40);INT(CL);TA
B(50);INT(FH);TAB(60);FB
390 NEXT T
470 SL=0
480 GO TO 210
490 V2=V3
500 GO TO 222

```



APPENDIX C
METHOD OF ESTIMATING DROGUE SIZE FOR
LARGE BOAT (60 FT. LOA, 60,000 LBS DP.)

The incidence of breaking wave capsize diminishes rapidly with increase in displacement. Larger yachts can, however, be accelerated to wave speed (surfing speed) by a breaking wave. The boat can reach a high velocity and may plunge into the preceding wave or may broach and roll down. This behavior can be prevented by the use of a properly designed drogue.

To select a drogue size for a boat displacing 60,000 lbs. the following conditions were assumed:

1. Breaking wave with a crest velocity of 39 ft./sec. corresponding to a wave length of 300 ft. This is representative of a wave height of approximately 40 feet.
2. The boat has been accelerated to wave speed and is riding the crest at a slope of 0.5 (27 deg.).
3. The hull drag is zero because the water in the crest is moving at the wave speed with the boat.
4. The wind drag is assumed to be 6000 lbs. (75 mph wind).
5. The boat is in a steady state with no horizontal or vertical acceleration.
6. The drag of the drogue must equal the horizontal component of the buoyancy force plus the wind force. Thus the boat will be held on the face of the wave until the crest dissipates.

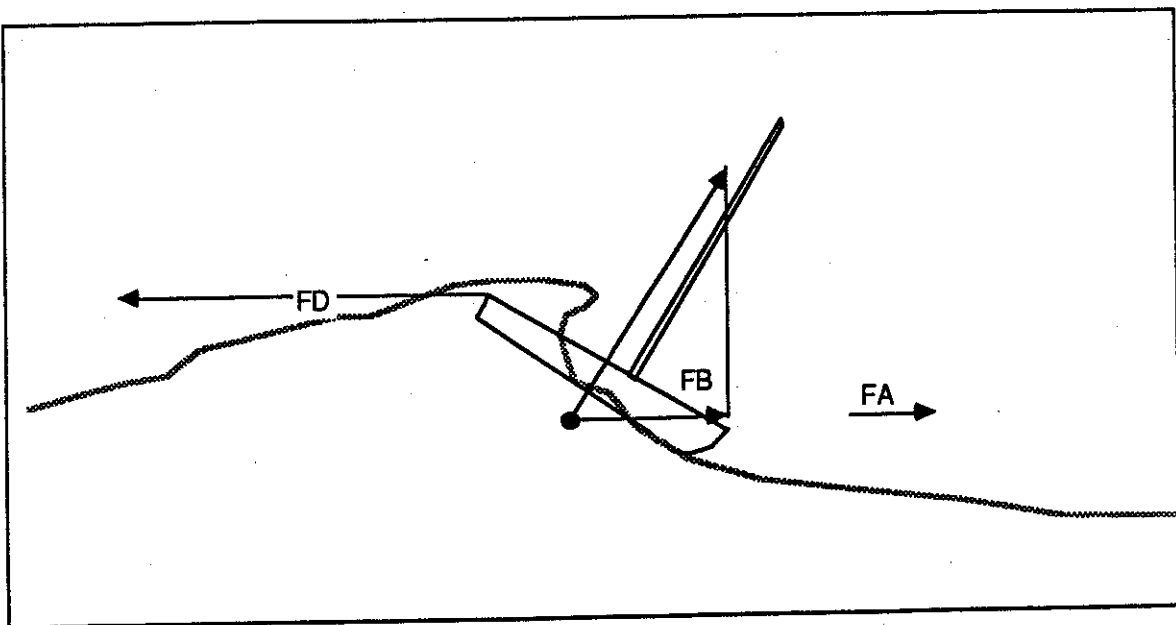
Figure 1C shows the assumed conditions:



FB = Horizontal component of buoyancy force = $60,000 \times 0.5 = 30,000$ lbs

FA = Air drag = 6000 lbs.

FD = Drogue force = $C_D A \rho/2 v^2 = 30,000 + 6000 = 36,000$ lbs.

C_D = Drag coefficient of drogue $\cong 1.0$, $\rho/2 \cong 1.0$

A = Drogue cross section area

V = Velocity of drogue = boat velocity = 39 ft./sec.

Required drogue area = $36,000 / (39)^2 = 23.7$ sq.ft.

Drogue diameter = $\sqrt{\frac{4A}{\pi}} = 5.5$ ft.

NTIS does not permit return of items for credit or refund. A replacement will be provided if an error is made in filling your order, if the item was received in damaged condition, or if the item is defective.

Reproduced by NTIS
National Technical Information Service
U.S. Department of Commerce
Springfield, VA 22161

This report was printed specifically for your order from our collection of more than 2 million technical reports.

For economy and efficiency, NTIS does not maintain stock of its vast collection of technical reports. Rather, most documents are printed for each order. Your copy is the best possible reproduction available from our master archive. If you have any questions concerning this document or any order you placed with NTIS, please call our Customer Services Department at (703)487-4660.

Always think of NTIS when you want:

- Access to the technical, scientific, and engineering results generated by the ongoing multibillion dollar R&D program of the U.S. Government.
- R&D results from Japan, West Germany, Great Britain, and some 20 other countries, most of it reported in English.

NTIS also operates two centers that can provide you with valuable information:

- The Federal Computer Products Center - offers software and datafiles produced by Federal agencies.
- The Center for the Utilization of Federal Technology - gives you access to the best of Federal technologies and laboratory resources.

For more information about NTIS, send for our FREE *NTIS Products and Services Catalog* which describes how you can access this U.S. and foreign Government technology. Call (703)487-4650 or send this sheet to NTIS, U.S. Department of Commerce, Springfield, VA 22161. Ask for catalog, PR-827.

Name _____

Address _____

Telephone _____

**- Your Source to U.S. and Foreign Government
Research and Technology.**



U.S. DEPARTMENT OF COMMERCE
Technology Administration
National Technical Information Service
Springfield, VA 22161 (703) 487-4650
