

Source: Leece-Neville Heavy Duty Systems Division - Arcade, NY USA
Date: July 7, 2017
Bulletin No: TSB-1061
Models: 2500, 2800, 4800 and 4900 Series
Subject: Brush inspection and replacement procedure

It is recommended that brush inspection be completed every 12 months beyond the original in service date on all applications except school bus. School bus applications should be inspected every 24 months from the in service date.

- 1) Remove 4 screws that attached the regulator to alternator (Fig 1).
- 2) Lift regulator from alternator. (Fig 2).
- 3) Remove brushes from brush box and inspect length. If brush length is $3/16''$ or less then brushes need to be replaced (Fig 3).

Part number for replacement brushes: K185104697S

Note: If brushes are within specifications note the orientation so they can be reinstalled in the location they were removed.

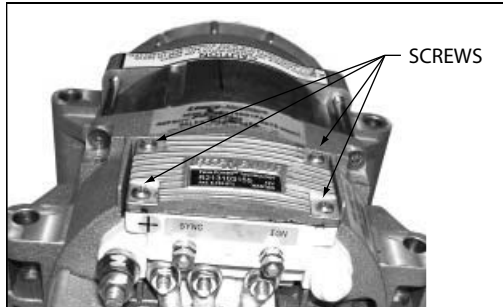

Fig 1

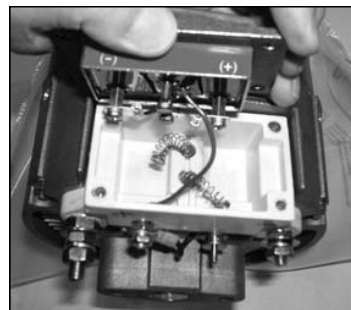

Fig 2

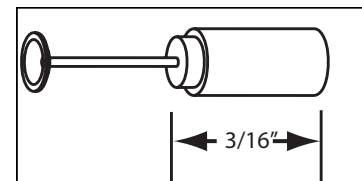

Fig 3

Minimal serviceable brush length
Note: New brush measures $7/8''$ long.
Replacement brushes: K185104697S

- 4) Reinstall brushes into brush holder. If existing brushes are reinstalled after inspection make certain to match wear pattern to slip ring (Fig 4). With brush placed into holder compress entire spring into holder and retain brush contact into opening with a $1/16''$ drill bit or mechanics wire. Install second brush following same procedure; slipping retaining pin forward through front opening of brush box to secure both brushes. (Fig 5).

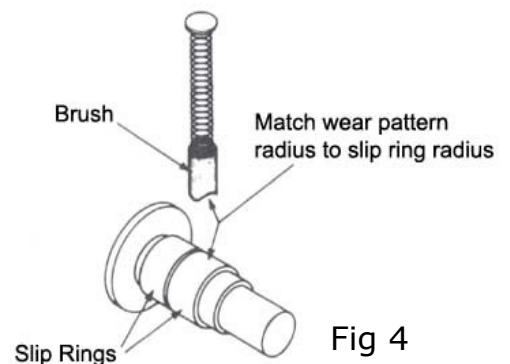

Fig 4

Important: The information contained in this bulletin is intended for use by trained, professional technicians who have the proper tools, equipment, and training to perform the required maintenance described above. This information is NOT intended for 'do-it-yourselfers'; and you should not assume that this information applies to your equipment. If you have any questions regarding this information please visit our website at www.prestolite.com, or contact our technical service department at:

Date: July 7, 2017

Bulletin No: TSB-1061

5) Place regulator back onto alternator. Use caution not to pinch regulator sense wires (Fig 6). Apply a small amount of downward pressure on the regulator and remove the retaining pin (Fig 5) from the Access Hole to release the brush springs. Hold down the regulator and secure it with 4 #8-32 screws. Torque screws to 11-13 LB-IN (Fig 1).

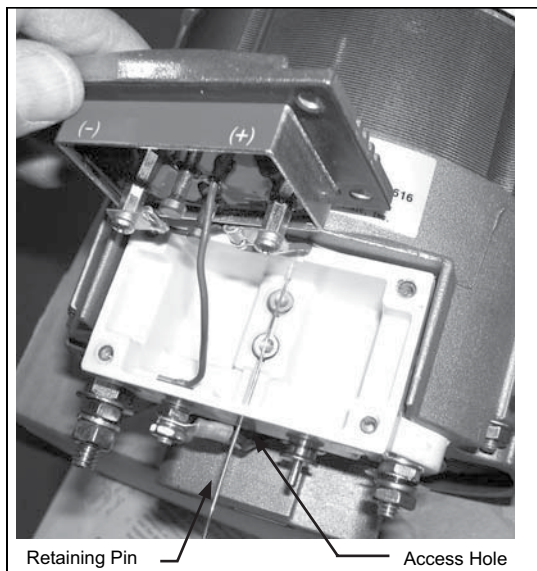

Fig 5



Fig 6

If the alternator fails to operate after the brushes are replaced a bad connection between the brushes and the regulator may be the problem. The procedures below will determine if this is the problem.

Internally Regulated Alternators

- 1) Engine must be off to conduct this test.
- 2) Make sure voltage is present at the alternator output terminals. Voltage should be 11.3V or greater if not charge batteries before proceeding.
- 3) Insert 1/16" drill bit or mechanics wire into alternators full field access hole. Insert straight into hole until it stops about 1/4" (Do Not Force). Hold firmly in place to ensure appropriate contact. Refer to Fig 5 on page two for location of this hole.

Important: The information contained in this bulletin is intended for use by trained, professional technicians who have the proper tools, equipment, and training to perform the required maintenance described above. This information is NOT intended for 'do-it-yourselfers', and you should not assume that this information applies to your equipment. If you have any questions regarding this information please visit our website at www.prestolite.com, or contact our technical service department at:

Date: July 7, 2017

Bulletin No: TSB-1061

4) Determine which type of alternator you have and connect voltmeter or test light per the diagrams below. One lead of the voltmeter gets connected to the 1/16" drill bit inserted in the alternators full field access hole. The other lead gets connected to the alternator ground terminal (Fig 7,8). If voltage is present or the light illuminates then the connection between the brushes and the regulator are good. If not, then the regulator will have to be removed and inspected for possible contamination between the brushes and regulator.

Note: It may be necessary to clean the regulator brush contacts with #600 grade or finer sandpaper.

Fig 7

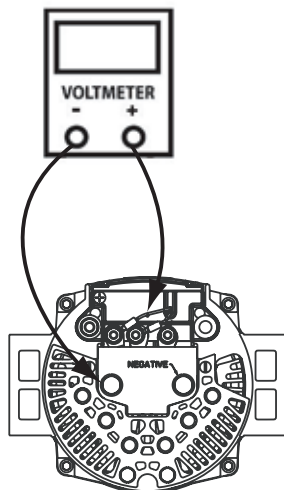
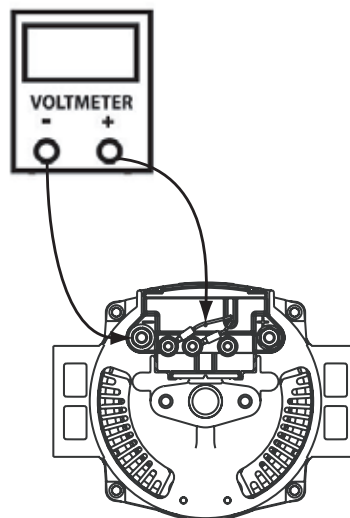

Figure 7 shows an example of 185 amp to 320 amp alternators.

Figure 8 shows an example of 105 amp to 175 amp alternators.

Fig 8



Remote Regulated Alternators

LN-614 regulator

- 1) Engine must be off to conduct this test.
- 2) Make sure voltage is present at the alternators output terminals. Voltage should be 11.3V or greater; if not, charge batteries before proceeding.
- 3) Connect a jumper wire from the alternator Positive (+) post to the Field Positive (F+) terminal. Connect voltmeter or test light per Fig 9.

Important: The information contained in this bulletin is intended for use by trained, professional technicians who have the proper tools, equipment, and training to perform the required maintenance described above. This information is NOT intended for 'do-it-yourselfers', and you should not assume that this information applies to your equipment. If you have any questions regarding this information please visit our website at www.prestolite.com, or contact our technical service department at:

Date: July 7, 2017

Bulletin No: TSB-1061

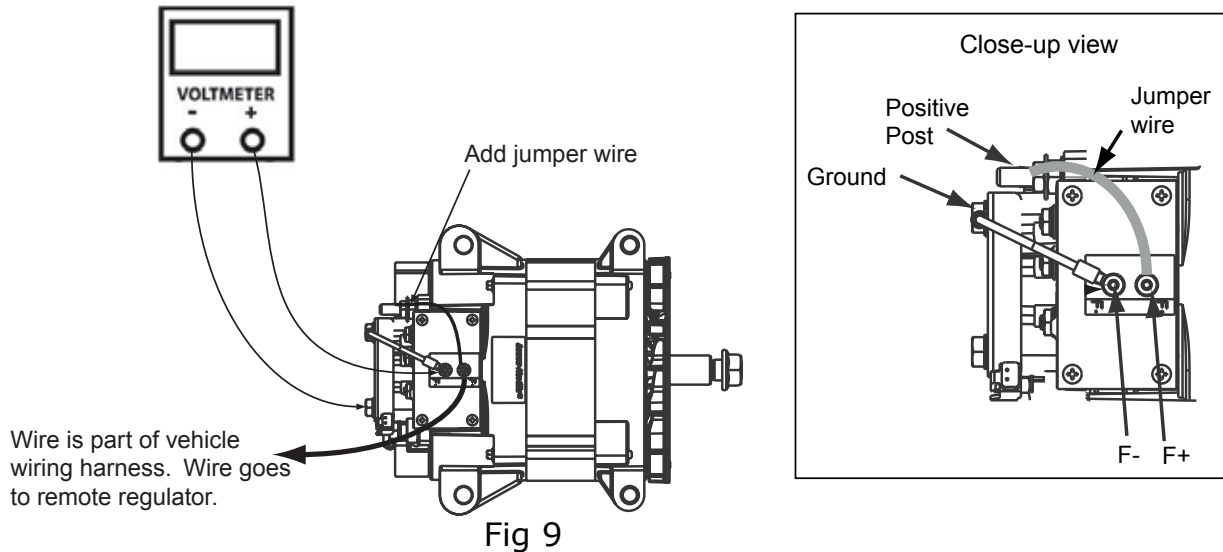

4) If voltage is present or the light illuminates then the connection between the brushes and the regulator are good. If not, then the regulator will have to be removed and inspected for possible contamination between the brushes and regulator.

Note: It may be necessary to clean the regulator brush contacts with #600 grade or finer sandpaper.

5) Remove jumper wire when test is complete.

Remote Regulated Alternators

8RD2041 or 5078R

1) Engine must be off to conduct this test.

2) Make sure voltage is present at the alternator output terminals. Voltage should be 11.3V or greater; if not, charge batteries before proceeding.

3) Determine which type of alternator you have and connect voltmeter or test light per the diagrams below. One lead of the voltmeter gets connected to the alternator F- terminal and the other lead gets connected to the alternator ground terminal (Refer to Fig 10, 11).

If voltage is present or the light illuminates then the connection between the regulator and brushes are good. If not, then the regulator will have to be removed and inspected for possible contamination between the brushes and regulator.

Note: It may be necessary to clean the regulator brush contacts with #600 grade or finer sandpaper.

Important: The information contained in this bulletin is intended for use by trained, professional technicians who have the proper tools, equipment, and training to perform the required maintenance described above. This information is NOT intended for 'do-it-yourselfers', and you should not assume that this information applies to your equipment. If you have any questions regarding this information please visit our website at www.prestolite.com, or contact our technical service department at:

Date: July 7, 2017

Bulletin No: TSB-1061

Fig 10

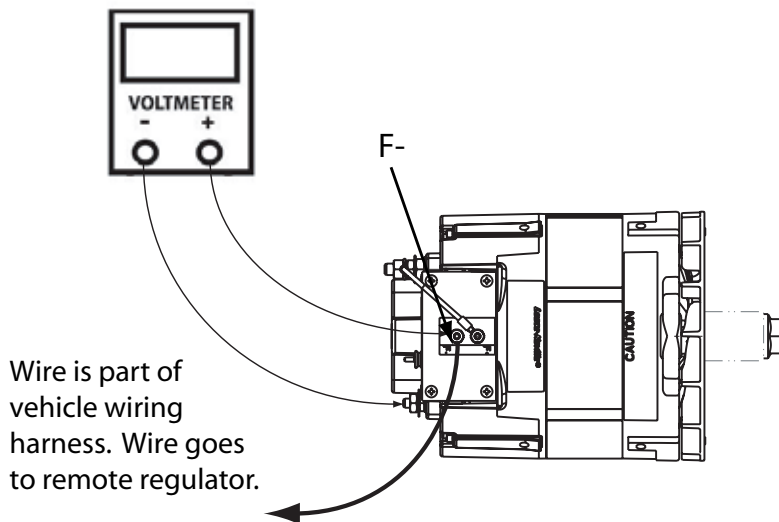
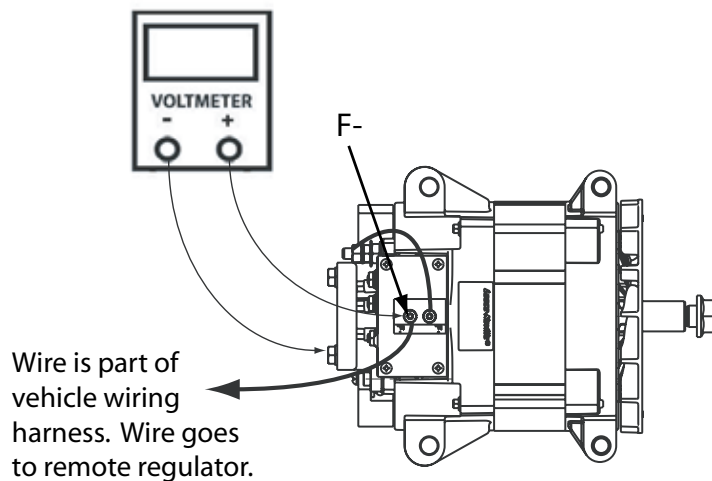

Fig 11



Important: The information contained in this bulletin is intended for use by trained, professional technicians who have the proper tools, equipment, and training to perform the required maintenance described above. This information is NOT intended for 'do-it-yourselfers', and you should not assume that this information applies to your equipment. If you have any questions regarding this information please visit our website at www.prestolite.com, or contact our technical service department at: