

GUIDE FOR CD

1) COMPOSITION

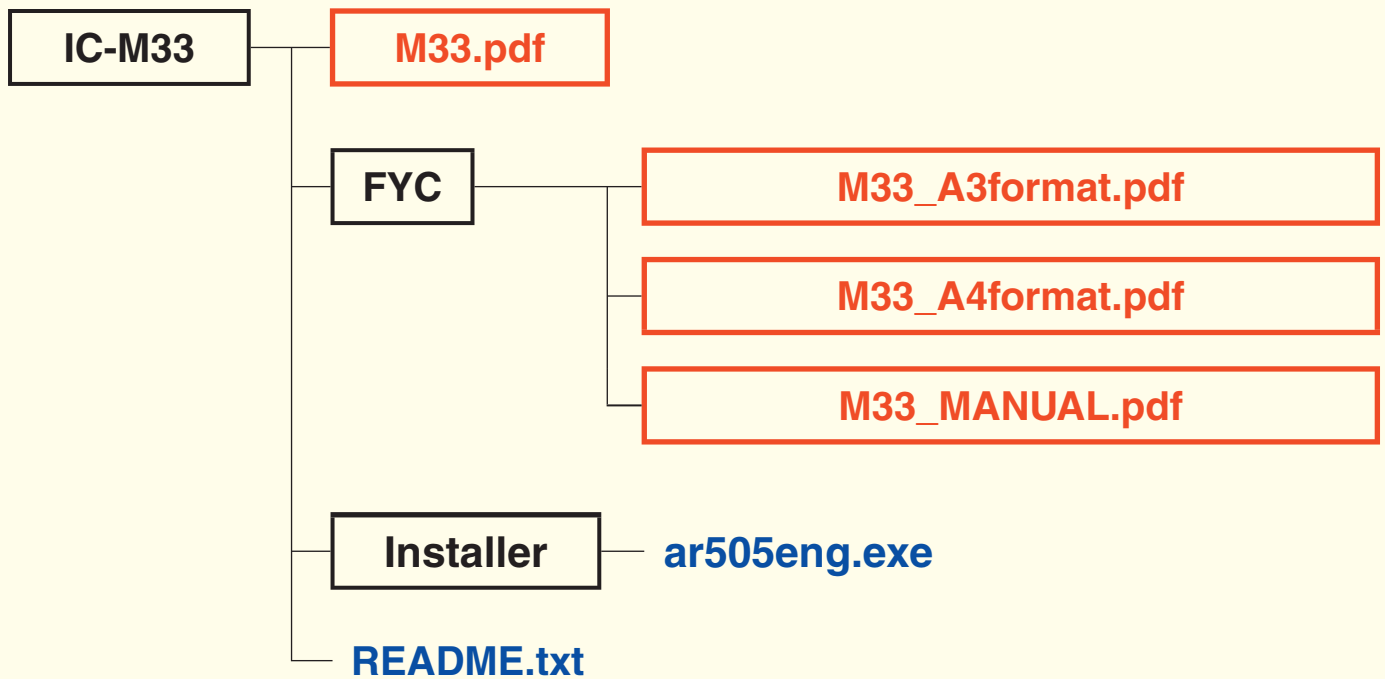

2) DESCRIPTION

M33.pdf

The service manual for IC-M33 including all service information in this CD. This file is mainly used for viewing on the computer display and checking page order to make printed service manual. Or when you want to find a component, you can find very fast using "FIND" function (except Board Layouts).

M33_A3format.pdf

Consists of A3 format pages (Board layouts, Mechanical parts and disassembly, and etc.). This file is used for printing out A3 format pages.

M33_A4format.pdf

Consists of A4 format pages (Board layouts, Mechanical parts and disassembly, and etc.). This file is used for printing out A4 format pages.

M33_MANUAL.pdf

The instruction manuals for IC-M33. The contents of this file is exactly same as supplied instruction manual with the product. If you have A4 format printer, you can print and make brand new instruction manual any time you want. This file is also very helpful when you want to change or set product setting condition for adjustment or else.

ar505eng.exe

ar505eng.exe is an installation program of Adobe Acrobat® Reader 5.0 (English version) for Microsoft® Windows® 95/98/Me/NT/2000/XP users.

README.txt

README.txt is a readme text about this service manual for Windows® user that not installed Acrobat® Reader yet.

=====
Icom, Icom Inc. and Icom logo are registered trademarks of Icom Incorporated (Japan) in the United states, the United Kingdom, Germany, France, Spain, Russia and/or other countries.

Acrobat Reader Copyright © 1987-2002 Adobe Systems Incorporated. All rights reserved.
Adobe, the Adobe logo, Acrobat, and the Acrobat logo are trademarks of Adobe Systems Incorporated.

Microsoft and Windows are registered trademarks of Microsoft Corporation in the U.S.A. and other countries.

Copyright 2006 Icom Inc.
=====



SERVICE MANUAL

VHF MARINE TRANSCEIVER

IC-M33

S-14320XZ-C1
Feb. 2007

Icom Inc.

INTRODUCTION

This service manual describes the latest service information for the **IC-M33** VHF MARINE TRANSCEIVER at the time of publication.

MODEL	VERSION	SYMBOL	AC ADAPTER
IC-M33	Europe	[EUR]	BC-174E
	U.K.	[UK]	
	Fragile	[FRG]	
	Holand	[HOL]	-
	Australia	[AUS]	BM-95V

To upgrade quality, any electrical or mechanical parts and internal circuits are subject to change without notice or obligation.

CAUTION

NEVER connect the transceiver to an AC outlet or to a DC power supply that uses more than 8 V. This will ruin the transceiver.

DO NOT reverse the polarities of the power supply when connecting the transceiver.

DO NOT apply an RF signal of more than 20 dBm (100 mW) to the antenna connector. This could damage the transceiver's front end.

ORDERING PARTS

Be sure to include the following four points when ordering replacement parts:

1. 10-digit order numbers
2. Component part number and name
3. Equipment model name and unit name
4. Quantity required

<SAMPLE ORDER>

1110003491 S.IC TA31136FNG IC-M33 MAIN UNIT 5 pieces
8820001210 Screw 2438 screw IC-M33 Top cover 10 pieces
Addresses are provided on the inside back cover for your convenience.



REPAIR NOTES

1. Make sure a problem is internal before disassembling the transceiver.
2. **DO NOT** open the transceiver until the transceiver is disconnected from its power source.
3. **DO NOT** force any of the variable components. Turn them slowly and smoothly.
4. **DO NOT** short any circuits or electronic parts. An insulated tuning tool **MUST** be used for all adjustments.
5. **DO NOT** keep power ON for a long time when the transceiver is defective.
6. **DO NOT** transmit power into a signal generator or a sweep generator.
7. **ALWAYS** connect a 50 dB to 60 dB attenuator between the transceiver and a deviation meter or spectrum analyzer when using such test equipment.
8. **READ** the instructions of test equipment thoroughly before connecting equipment to the transceiver.

CONTENTS

SECTION 1 SPECIFICATIONS

SECTION 2 INSIDE VIEWS

SECTION 3 DISASSEMBLY INSTRUCTIONS

SECTION 4 CIRCUIT DESCRIPITON

4-1	RECEIVER CIRCUITS.....	4-1
4-2	TRANSMITTER CIRCUITS.....	4-2
4-3	PLL CIRCUITS.....	4-3
4-5	POWER SUPPLY CIRCUITS.....	4-3
4-6	CPU PORT ALLOCATIONS.....	4-4

SECTION 5 ADJUSTMENT PROCEDURES

5-1	PREPARATION.....	5-1
5-2	SOFTWARE ADJUSTMENT (FREQUENCY).....	5-2
5-3	SOFTWARE (TRANSMIT AND RECEIVE).....	5-3

SECTION 6 PARTS LIST

SECTION 7 MECHANICAL PARTS AND DISASSEMBLY

SECTION 8 SEMICONDUCTOR INFORMATION

SECTION 9 BOARD LAYOUTS

SECTION 10 BLOCK DIAGRAM

SECTION 11 VOLTAGE DIAGRAM

11-1	MAIN UNIT (Left side).....	11-1
11-2	MAIN UNIT (Right side).....	11-2

SECTION 12 BC-173

■ GENERAL

• Frequency coverage	: TX	156.000–161.450 MHz [EUR], [UK], [FRG], [HOL] 156.025–157.425 MHz [AUS]
	RX	156.000–163.425 MHz [EUR], [UK], [FRG], [HOL] 156.300–162.025 MHz [AUS]
• Type of emission	: 16K0G3E	
• Antenna impedance	: 50 Ω (Nominal)	
• Operating temperature range	: –15°C to +55°C [EUR], [UK], [FRG], [HOL] –10°C to +55°C [AUS]	
• Power supply requirement (negative ground)	: Specified Icom's battery pack Operating voltage; 7.2 V DC [EUR], [UK], [FRG], [HOL] 7.5 V DC [AUS]	
• Current drain (At 13.8 V DC ; approx.)	: Receiving; 0.2 A (at max. audio) Transmitting; 1.5 A (at 5.0 W) 1.0 A (at 2.0 W) 0.7 A (at 1.0 W) 0.6 A (at 0.5 W) [FRG] only	
• Dimensions (Projections not included)	: 62×141.5×43 mm	
• Weight (Approx.)	: 305 g (incl. BP-252, FA-SC58V and MB-109)	

■ TRANSMITTER

• Output power (At 13.8 V DC)	: 5 W (HI)/2 W (AL_HI)/1 W (LOW) [EUR], [UK], [HOL], [AUS] 1 W (HI)/0.5 W (LOW) [FRG]
• Modulation	: Variable reactance frequency modulation
• Maximum frequency deviation	: ± 5 kHz
• Frequency stability	: ± 1.5 kHz [EUR], [UK], [FRG], [HOL] ± 10 ppm [AUS]
• Spurious emissions	: 0.25 μ W
• Adjacent channel power	: 70 dB
• Audio harmonic distortion	: 10% (at 60% deviation)
• Residual modulation	: 40 dB
• Audio frequency response	: +1 dB to –3 dB of 6 dB oct. from 300 Hz to 3000 Hz
• Microphone impedance	: 2 k Ω

■ RECEIVER

• Receive system	: Double conversion superheterodyne system
• Intermediate frequencies	: 1st IF: 21.7 MHz, 2nd IF: 450 kHz
• Sensitivity	: –2 dB μ emf typ. at 20 dB SINAD [EUR], [UK], [FRG], [HOL] –5 dB μ emf typ. at 20 dB SINAD [AUS]
• Squelch sensitivity	: –6 dB μ emf typ. (at threshold)
• Adjacent channel selectivity	: 70 dB [EUR], [UK], [FRG], [HOL] 65 dB [AUS]
• Spurious response	: 70 dB [EUR], [UK], [FRG], [HOL] 60 dB [AUS]
• Intermodulation rejection ratio	: 68 dB [EUR], [UK], [FRG], [HOL] 65 dB [AUS]
• Hum and Noise	: 40 dB [EUR], [UK], [FRG], [HOL] 35 dB [AUS]
• Audio frequency response	: +1 dB to –3 dB of –6 dB oct. from 300 Hz to 3000 Hz
• Audio output power (At 10% distortion with an 8 Ω load)	: 0.2 W [EUR], [UK], [FRG], [HOL] 0.35 W typ. [AUS]
• Audio output impedance	: 8 Ω

Specifications are measured in accordance with EN301-178-2 ([EUR], [UK], [FRG], [HOL]) or AS/NZS 4415. 2-2003 ([AUS]).

All stated specifications are subject to change without notice or obligation.

• CHANNEL LIST

• International channels

CH	Frequency (MHz)		CH	Frequency (MHz)		CH	Frequency (MHz)		CH	Frequency (MHz)		CH	Frequency (MHz)		CH	Frequency (MHz)	
	Transmit	Receive		Transmit	Receive		Transmit	Receive		Transmit	Receive		Transmit	Receive		Transmit	Receive
01	156.050	160.650	11	156.550	156.550	21	157.050	161.650	62	156.125	160.725	72	156.625	156.625	82	157.125	161.725
02	156.100	160.700	12	156.600	156.600	22	157.100	161.700	63	156.175	160.775	73	156.675	156.675	83	157.175	161.775
03	156.150	160.750	13	156.650	156.650	23	157.150	161.750	64	156.225	160.825	74	156.725	156.725	84	157.225	161.825
04	156.200	160.800	14	156.700	156.700	24	157.200	161.800	65	156.275	160.875	75*2	156.775	156.775	85	157.275	161.875
05	156.250	160.850	15*1	156.750	156.750	25	157.250	161.850	66	156.325	160.925	76*2	156.825	156.825	86	157.325	161.925
06	156.300	156.300	16	156.800	156.800	26	157.300	161.900	67	156.375	156.375	77	156.875	156.875	87	157.375	157.375
07	156.350	160.950	17*1	156.850	156.850	27	157.350	161.950	68	156.425	156.425	78	156.925	161.525	88	157.425	157.425
08	156.400	156.400	18	156.900	161.500	28	157.400	162.000	69	156.475	156.475	79	156.975	161.575			
09	156.450	156.450	19	156.950	161.550	60	156.025	160.625	70	Rx only	156.525	80	157.025	161.625			
10	156.500	156.500	20	157.000	161.600	61	156.075	160.675	71	156.575	156.575	81	157.075	161.675			

*1 Channels 15 and 17 may also be used for on-board communications provided the effective radiated power does not exceed 1 W, and subject to the national regulations of the administration concerned when these channels are used in its territorial waters.

*2 The use of these channels should be restricted to navigation-related communications only and all precautions should be taken to avoid harmful interference to channel 16, e.g. by limiting the output power to 1 W or by means geographical separation.

• USA channels (for U.K. and Australia versions only)

CH	Frequency (MHz)		CH	Frequency (MHz)		CH	Frequency (MHz)		CH	Frequency (MHz)		CH	Frequency (MHz)		CH	Frequency (MHz)	
	Transmit	Receive		Transmit	Receive		Transmit	Receive		Transmit	Receive		Transmit	Receive		Transmit	Receive
01A	156.050	156.050	12	156.600	156.600	22A	157.100	157.100	64A	156.225	156.225	77	156.875	156.875	86	157.325	161.925
—	—	—	13	156.650	156.650	23A	157.150	157.150	65A	156.275	156.275	78A	156.925	156.925	86A	157.325	157.325
03A	156.150	156.150	14	156.700	156.700	24	157.200	161.800	66A	156.325	156.325	79A	156.975	156.975	87	157.375	161.975
—	—	—	15	156.750	156.750	25	157.250	161.850	67	156.375	156.375	80A	157.025	157.025	87A	157.375	157.375
05A	156.250	156.250	16	156.800	156.800	26	157.300	161.900	68	156.425	156.425	81A	157.075	157.075	88	157.425	162.025
06	156.300	156.300	17	156.850	156.850	27	157.350	161.950	69	156.475	156.475	82A	157.125	157.125	88A	157.425	157.425
07A	156.350	156.350	18A	156.900	156.900	28	157.400	162.000	70	Rx only	156.525	83A	157.175	157.175	P4*	161.425	161.425
08	156.400	156.400	19A	156.950	156.950	37A*	157.850	157.850	71	156.575	156.575	84	157.225	161.825			
09	156.450	156.450	20	157.000	161.600	61A	156.075	156.075	72	156.625	156.625	84A	157.225	157.225			
10	156.500	156.500	20A	157.000	157.000	—	—	—	73	156.675	156.675	85	157.275	161.875			
11	156.550	156.550	21A	157.050	157.050	63A	156.175	156.175	74	156.725	156.725	85A	157.275	157.275			

*UK marina channels: M1=37A (Tx/Rx: 157.850 MHz), M2=P4 (Tx/Rx: 161.425 MHz) for U.K. versions only.

SECTION 2

INSIDE VIEWS

• MAIN UNIT (TOP VIEW)

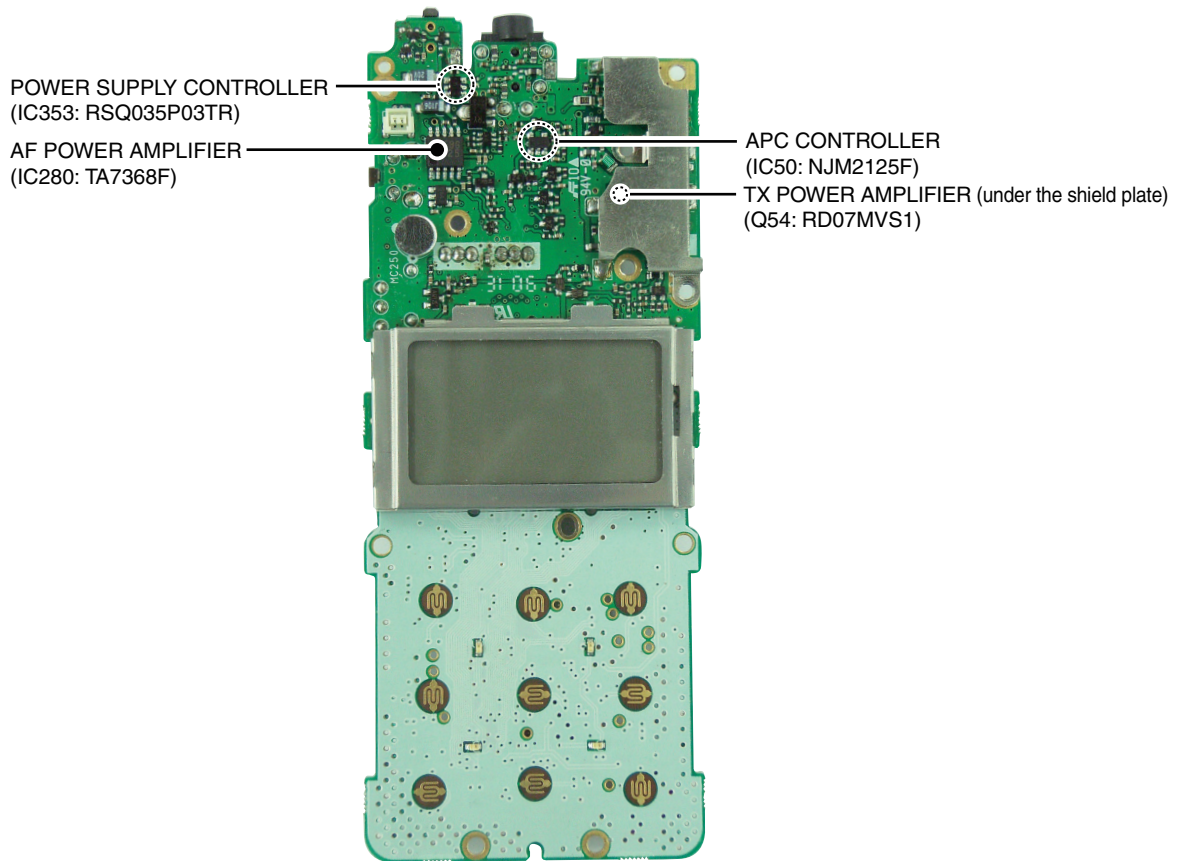

• MAIN UNIT (BOTTOM VIEW)

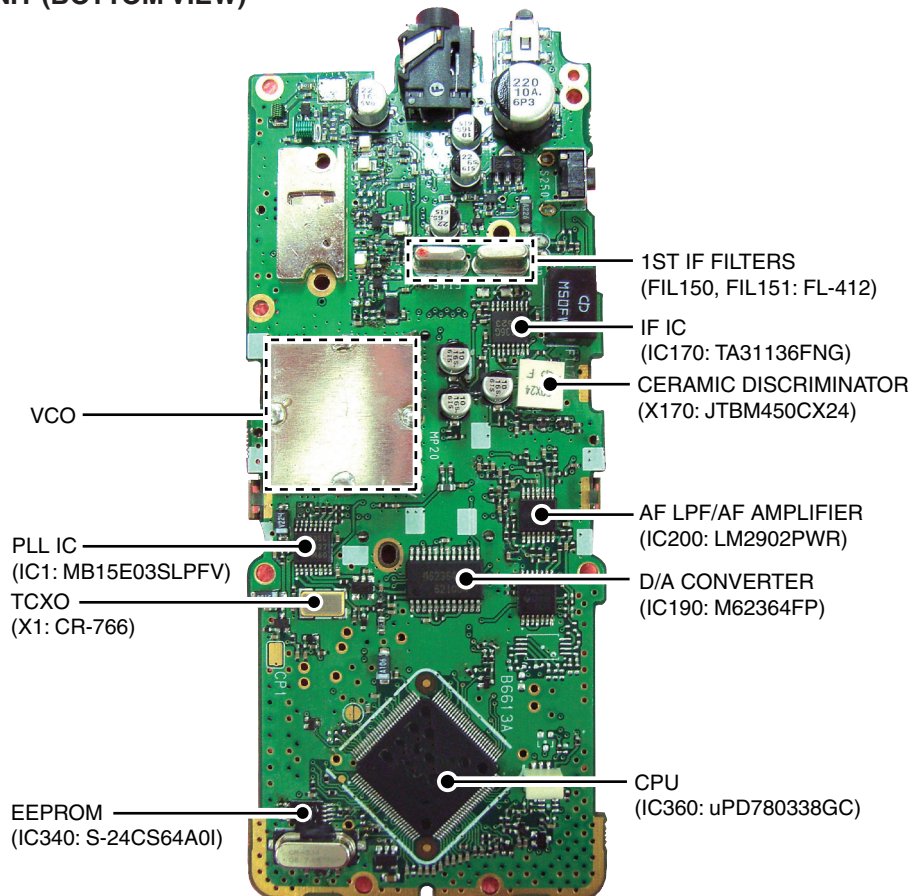

SECTION 3 DISASSEMBLY INSTRUCTION

1. Removing the Front panel

- Unscrew 4 screws (A), and remove the rear panel from the Front panel.

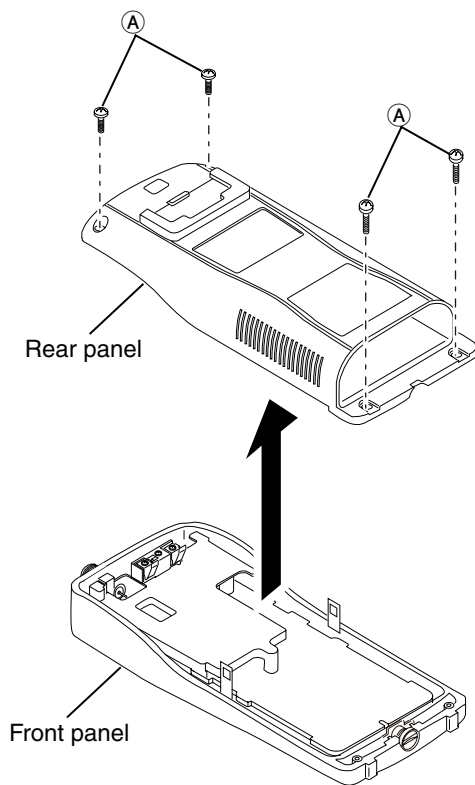

2. Removing the Chassis

- ① Unscrew the antenna nut and 4 screws (B).
- ② Disconnect the speaker cable from the MAIN UNIT.
- ③ Take off the chassis from the front panel in the direction of the arrow.

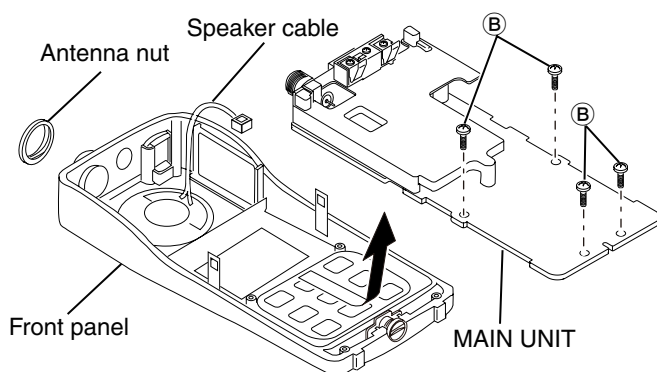

3. Removing the MAIN UNIT

- ① Unsolder 2 points (C) on the bottom side of the MAIN UNIT.
- ② Unsolder 1 point (D) (the core of the antenna connector).
- ③ Unscrew 7 screws (E), and remove the chassis from the MAIN UNIT.

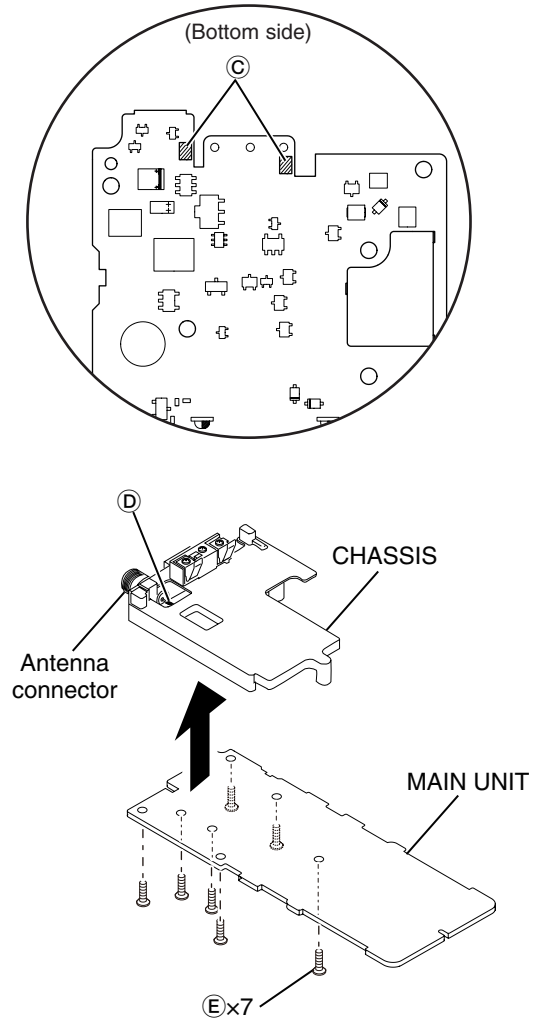

4-1 RECEIVER CIRCUITS

4-1-1 ANTENNA SWITCH

The received signals from the antenna connector are passed through the antenna switch which toggles the receive (RX) line and transmit (TX) line.

The received signals from the antenna connector are passed through the low-pass filter (LPF; L81, L82, C80, C83 -C86, C89) and the antenna switch (D52, D90 and D353 are OFF).

While transmitting, the voltage on the T5V line is applied to D52, D90 and D353, and these are ON. Thus the TX line is connected to the antenna, and RX line is connected to the GND to prevent transmit signal entering.

While receiving, no voltage is applied to D52, D90 and D353, and these are OFF. Thus the TX line and the antenna is disconnected to prevent received signals entering, and RX line is disconnected from the GND and L90, C90-C92 compose an LPF which guides received signals to the RX circuits.

The received signals are applied to the RF circuits.

4-1-2 RF CIRCUITS

The RF circuit amplifies received signals within the frequency coverage. The received signals are filtered at the bandpass filter (BPF) and amplified at the RF amplifier.

The received signals from the antenna switch are passed through the two-staged tunable BPF (D92, D93, L92, L93, C95, C97-C101) to filter out unwanted signals. The filtered signals are applied to the RF amplifier (Q90). The amplified signals are then applied to the 1st mixer (Q150) via another two-staged tunable BPF (D130, D131, L96, L97, C104, C109, C110, C112-C116).

4-1-3 1st IF CIRCUITS

The received signals are converted into the 1st IF signal, and amplified at the 1st IF circuits.

The amplified received signals from the RF circuits are applied to the 1st mixer (Q150), and converted into the 21.7 MHz 1st IF signal by being mixed with the 1st local oscillator (LO) signals from the VCO (Q21, Q22, D21-D23).

The converted 1st IF signal is passed through two 1st IF filters (F150, F151) to filter out unwanted signals, and applied to the 1st IF amplifier (Q151). The amplified 1st IF signal is then applied to the FM IF IC (IC170, pin 16).

• 1st IF CIRCUITS

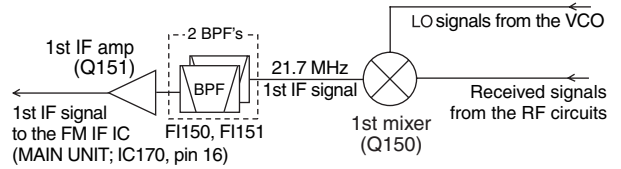

4-1-4 2nd IF AND DEMODULATOR CIRCUITS

The 1st IF signal is converted into the 2nd IF signal, and demodulated.

The 1st IF signal from the 1st IF circuits is applied to the 2nd IF mixer in the FM IF IC (IC170, pin 16) and converted into the 2nd IF signal by being mixed with the 21.25 MHz 2nd LO signal from the reference oscillator (IC1, X1) via LPF (L1, C8, C9, C12).

The converted 2nd IF signal is output from pin 3, and passed through the 2nd IF filter (F1170) to suppress sideband noise. The filtered 2nd IF signal is applied to the limiter amplifier (IC170, pin 5). The amplified 2nd IF signal is FM-demodulated at the quadrature detector (IC170, pins 10, 11) and output from pin 9. The demodulated AF signals are applied to the AF circuits.

4-1-5 AF CIRCUITS

The demodulated AF signals from the demodulator circuits are amplified and filtered in AF amplifier circuits.

The demodulated AF signals from the FM IF IC (IC170, pin 9) are passed through the AF mute switch (IC260, pins 1, 2), LPF (IC200, pins 8, 9) and variable register (VR BOARD; R801) for level adjustment.

The level adjusted AF signals are passed through the de-emphasis circuit (R286, C280, C285) to obtain -6 dB of audio characteristic. The de-emphasized AF signals are passed through the analog switch (IC430, pins 10, 11), and applied to the AF power amplifier (IC401, pin 7) to obtain AF output power level. The power-amplified AF signals are then output from pin 1, and applied to the internal speaker via J251.

• 2ND IF AND DEMODULATOR CIRCUITS

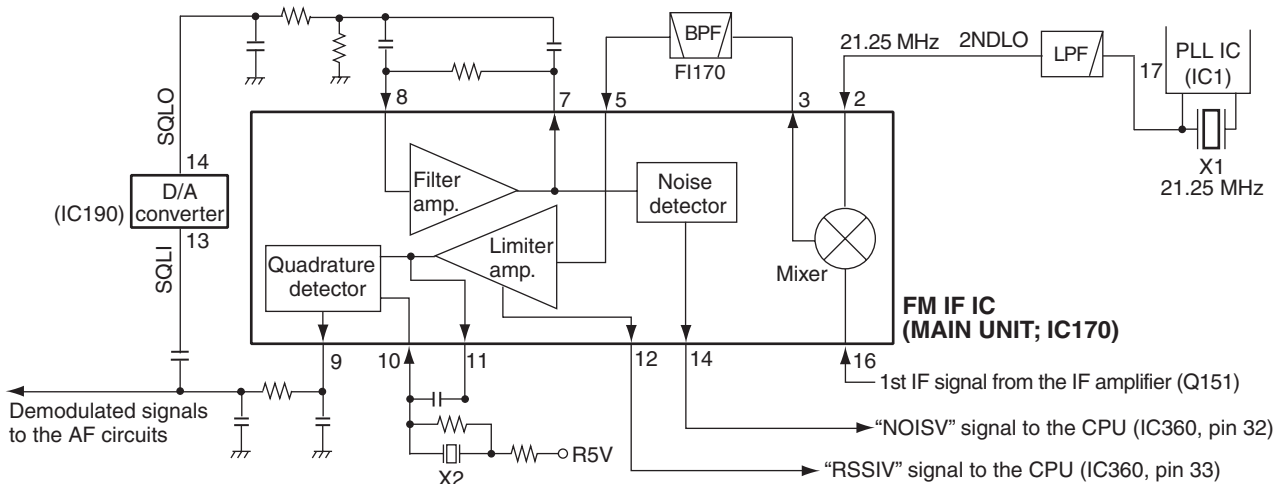

If an external speaker-microphone or headset is attached to the [SP MIC] connector (J250), the de-emphasized AF signals are passed through the analog switch (IC430, pins 8, 9) and applied to the AF power amplifier (IC280, pin 4) to obtain AF output power level. The power-amplified AF signals are output from pin 10, and then applied to the external speaker via the [SP MIC] connector (J416).

4-1-6 SQUELCH CIRCUIT

The squelch mutes the AF output signals when no RF signals are received. By detecting noise components in the demodulated AF signals, the squelch circuit toggles the AF power amplifier ON and OFF.

A portion of the demodulated AF signals from the FM IF IC (IC170, pin 9) are applied to the D/A converter (IC190, pin 13) for level adjustment (squelch threshold adjustment). The level-adjusted AF signals are output from pin 14, and passed through the noise filter (R174–R176, C177, C179, C180). The filtered noise signals are then applied to the noise amplifier in the FM IF IC (IC170, pins 7, 8) to be amplified the noise components only.

The amplified noise components are converted into the pulse-type signal at the noise detector section, and output from pin 14 as the “NOISV” signal. The signal is applied to the CPU (IC360, pin 32), and the CPU outputs “AFVS” signal from pin 100 according to the “NOISV” signal level, to the AF power regulator (Q230, Q231, Q401, Q540) which toggles the AF power amplifier ON and OFF.

4-2 TRANSMITTER CIRCUITS

4-2-1 MICROPHONE AMPLIFIER CIRCUITS

The AF signals from the microphone (MIC signals) are filtered and level-adjusted at microphone amplifier circuits.

The AF signals from the microphone are passed through the AF mute switch (IC430, pins 1, 2).

While an external microphone is connected to the [SP MIC] connector (J416), the mute switch shuts out the AF signals from the internal microphone (MC1).

AF signals from the AF mute switch (IC430, pins 1, 2) are passed through another AF mute switch (IC430, pins 3, 4), and passed through the pre-emphasis circuit (R253, C254) to obtain +3 dB of characteristic. The pre-emphasized signals are then applied to the microphone amplifier (IC200, pins 6, 7). The amplified MIC signals are passed through AF mute switch (IC260, pins 8, 9), and are applied to the gain controller (Q450, Q451) which adjust the AF signal level (=deviation) according to the control signals (“MIC1/2/3”) from the CPU (IC360, pins 106/107/108).

The level adjusted MIC (MOD) signals are applied to the limiter amplifier (IC200, pins 13, 14) which limits the amplitude of the MIC signals to prevent over deviation. The amplitude-limited MIC signals are then passed through the splatter filter (IC200, pins 1, 3) which suppresses the 3 kHz and higher audio components.

The filtered MIC signals are applied to the modulation circuit (D20).

4-2-2 MODULATION CIRCUIT

The modulation circuit modulates the VCO oscillating signal with the AF signals from the microphone.

The MIC signals from the microphone amplifier circuits are applied to the D20, and modulate the VCO oscillating signal by changing the reactance of D20. The modulated VCO output signal is buffer-amplified by Q23 and Q24, then applied to transmit amplifiers as a transmit signal via the TX/RX switch (D50 is ON, D51 is OFF).

4-2-3 TRANSMIT AMPLIFIERS

The VCO output signal is amplified to transmit output power level by the transmit amplifiers.

The transmit signal from the TX/RX switch (D50) is applied to the buffer amplifier (Q50). The amplified transmit signal is amplified to the transmit output level by the pre-driver (Q53) and power amplifier (Q54). The power-amplified transmit signal is passed through the TX power detector of APC circuit (D91), antenna switch (D52, D90 and D353 are ON), TX power detector for transmit indicator (D80) and LPF (as a harmonic filter; L81, L82, C80, C83–C86, C89, C226) before being applied to the antenna connector (CHASSIS; J1).

4-2-1 APC CIRCUIT

The APC (Automatic Power Control) circuit stabilizes transmit output power to prevent transmit output power level change which is caused by load mismatching or heat effect, etc.. The APC circuit also selects transmit output power from high, middle and low power.

The power detector circuits (D91) detects the transmit output and converts it into DC voltage which is in proportion to the transmit output power level. The detected voltage is applied to the differential amplifier (IC50, pin 3). The transmit power setting voltage “PCON” is applied to another input terminal (pin 1) as the reference voltage.

The differential amplifier compares the detected voltage and reference voltage, and the difference of the voltage is output from pin 4. The output voltage controls the bias of the buffer amplifier (Q50), pre-driver (Q53) and power amplifier (Q54) to reduce/increase the gain of transmit amplifiers for stable transmit output power.

The change of transmit power is carried out by the change of reference voltage “PCON” and “LOW.”

• APC CIRCUIT

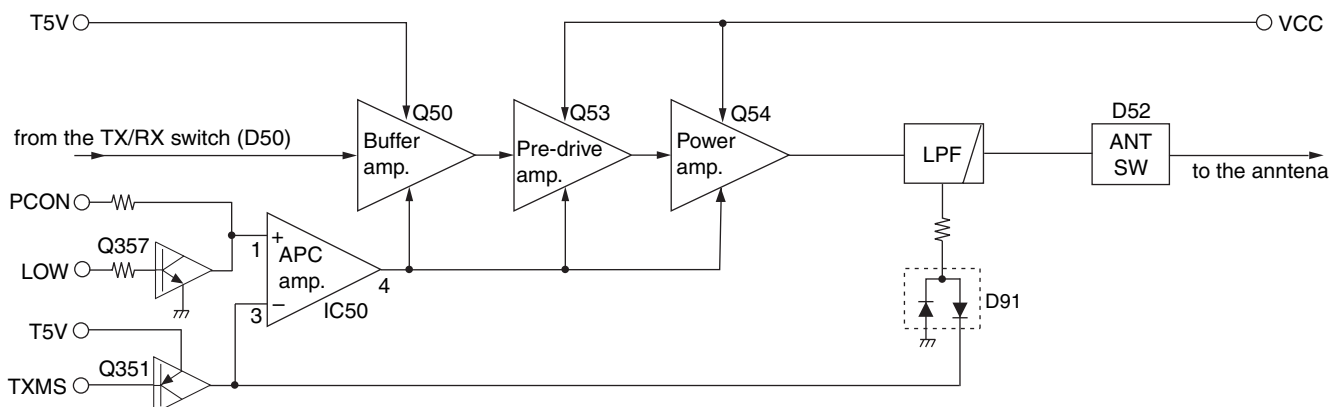

4-3 PLL CIRCUITS

4-3-1 VCO CIRCUIT

The VCO (Q21, Q22, D21–D23) generates the both of transmit signal and LO signals for the 1st IF conversion. The VCO output signals are buffer-amplified by Q23 and Q24.

While transmitting, the VCO output signal is applied to the transmit amplifiers via TX/RX switch (D50 is ON, D51 is OFF).

While receiving, the VCO output signals are applied to the 1st mixer (Q150) via the TX/RX switch (D50 is OFF, D51 is ON) the BPF (L26, C122, C123, C130, C131), to be mixed with the received signals to produce the 21.7 MHz 1st IF signal.

A portion of the VCO output is applied to the PLL IC (IC1, pin 19) via the buffer amplifier (Q25) and LPF (L20, R20, C20–C22).

4-3-2 PLL CIRCUIT

The PLL circuit provides stable oscillation of the transmit frequency and receive 1st LO frequency. The PLL output frequency is controlled by the divided ratio (N-data) from the CPU.

The buffer-amplified signals from the LPF (L20, R20, C20–C22) are applied to the PLL IC (IC1, pin 8). The applied signals are divided at the prescaler and programmable counter according to the "SDATA (SDATAO)" signal from the CPU (IC360, pin 10). The divided signal is phase-compared with the reference frequency signal which is divided by reference counter, at the phase detector.

The phase difference is output from pin 5 as a pulse type signal after being passed through the charge pump. The output signal is converted into the DC voltage (lock voltage) by passed through the loop filter (R8–R10, R22, C10, C11, C24, C25). The lock voltage is applied to the variable capacitors (D22, D23) of the VCO (Q21, Q22, D21–D23) and locked to keep the VCO frequency constant.

If the oscillated signal drifts, its phase changes from that of the reference frequency, causing a lock voltage change to compensate for the drift in the VCO oscillating frequency.

• PLL CIRCUITS

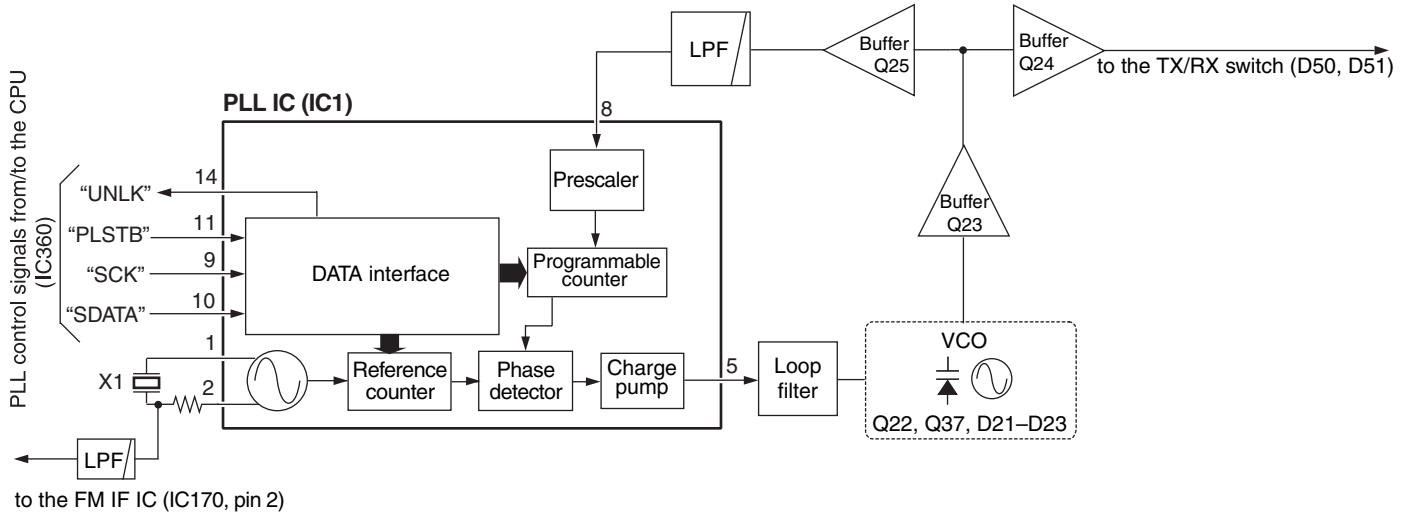

4-4 POWER SUPPLY CIRCUITS

Line name	Description
VCC	The same voltage as attached battery pack.
CPU5V	Common 5 V converted from VCC line at the CPU5V regulator (IC220). The converted voltage is applied to the CPU (IC360), Reset IC (IC341), EEPROM (IC340), etc.
5V	Common 5 V converted from VCC line at the 5V regulator (Q223–Q225) controlled by "5VS" signal from CPU (IC360, pin 86). The converted voltage is applied to the backlight LED'S (DS240–DS243, DS250–DS253), D/A converter (IC190), PLL IC (IC1), etc.

Line name	Description
V5V	Common 5 V converted from VCC line at the V5V regulator (Q220). The converted voltage is applied to the VCO (Q21, Q22, D21–D23)
R5V	Receive 5 V controlled by R5V regulator (Q221) using "R5VS" signal from the CPU (IC360, pin 89). The voltage is applied to the receive circuits (1st mixer (Q150), 1st IF amplifier (Q151), RF amplifier (Q90), etc.).
T5V	Transmit 5 V controlled by T5V regulator (Q222) using "T5VS" signal from the CPU (IC360, pin 86). The controlled voltage is applied to the transmit circuits (differential amplifier (IC50), pre-driver (Q53), power amplifier (Q54), microphone amplifier (IC200), etc.).

4-5 CPU PORT ALLOCATION

Pin No.	Port Name	Signal Description	I/O
1	BEEP	Beep sounds.	OUT
2	PS	PLL mode control signal. "Low"=power save mode.	OUT
3	TDEC	Tone signals.	OUT
4	DASTB	Strobe signal to D/A converter.	OUT
5	PLSTB	Strobe signal to the PLL IC.	OUT
10	SDATAO	Common serial data.	OUT
11	SCLK	Common clock signal.	OUT
12	ESCK	Common clock signal to the EEPROM.	OUT
13	ESDA	Data signal to the EEPROM.	IN/ OUT
23, 24	OSC2, OSC1	CPU clock input.	IN
25	RES	CPU reset signal.	OUT
27	TEMPV	Transceiver's internal temperature.	IN
29	LOINV	Lock voltage from the PLL IC.	IN
30	TDETV	Transmit power detect signal.	IN
31	BATTV	Battery voltage.	IN
32	RSSIV	RSSI signal from IF IC.	IN
33	NOISV	Noise signal from IF IC.	IN
35	EXDET	External connection detect signal.	IN
36	WDECV	Weather alert signal.	IN
38	ATIS	ATIS signals.	
46- 48	COM0- COM2	LCD segments.	OUT
51- 72	SEG0-21	LCD segments.	OUT
80	MICMS	Microphone mute signal.	OUT
83	AFMS	AF mute switch control signal.	OUT
84	V5VS	V5V power line control signal.	
85	AFVS	AF power amplifier switch control signal.	OUT
86	5VS	5V power line control signal.	OUT
87	S5VS	S5V power line control signal.	OUT
88	LOW	TX power control signal. "High"=While the TX power is low..	OUT
89	R5VS	R5V power line control signal. "High"=While receiving.	OUT
90	T5VS	T5V power line control signal. "High"=While transmitting.	OUT
97	TXMS	Transmit mute signal.	OUT
98	DETMS	AF mute signal to the D/A converter.	
99	ATTS	Attenuator control signal. "High"=While the attenuator function is activated.	OUT
102	EXPTT	Input port for external [PTT] switch. "Low"=While the switch is pushed	IN
103	PTTIN	Input port for [PTT] switch. "Low"=While the switch is pushed	IN
104	BTYPE	Battery type detection signal.	IN
106	WET	Leaking detection.	IN
108	16/9	Input port for [16/9] key. "Low"=While the key is pushed	IN
109	CH/WX	Input port for [CH/WX] key. "Low"=While the key is pushed	IN
110	UP	Input port for [▲] key. "Low"=While the key is pushed	IN
111	DOWN	Input port for [▼] key. "Low"=While the key is pushed	IN
112	FAV	Input port for [FAV] key. "Low"=While the key is pushed	IN
113	VOL	Input port for [VOL] key. "Low"=While the key is pushed	IN
114	SCAN	Input port for [SCAN] key. "Low"=While the key is pushed	IN

Pin No.	Port Name	Signal Description	I/O
115	SQL	Input port for [SQL] key. "Low"=While the key is pushed	IN
116	H/L	Inputport for [H/L] key. "Low"=While the key is pushed	IN
120	UNLKI	PLL unlock detect signal. "High"=While the PLL circuit is unlocked.	IN

SECTION 5 ADJUSTMENT PROCEDURE

5-1 PREPARATION

■ REQUIRED TEST EQUIPMENTS

When adjusting IC-M33, the optional CS-M34 ADJ ADJUSTMENT SOFTWARE (Rev. 1.0 or later), OPC-478 (RS-232C type) or OPC-478U/UC (USB type) CLONING CABLE and a JIG cable (modified OPC-1668, see page 5-2) are required.

EQUIPMENT	GRADE AND RANGE	EQUIPMENT	GRADE AND RANGE
RF power meter (terminated type)	Measuring range : 0.1–10 W Frequency range : 100–300 MHz Impedance : 50 Ω SWR : Less than 1.2 : 1	Standard signal generator (SSG)	Frequency range : 0.1–300 MHz Output level : 0.1 μV to 32 mV (–127 to –17 dBm)
Frequency counter	Frequency range : 0.1–300 MHz Frequency accuracy: ±1 ppm or better Sensitivity : 100 mV or better	FM deviation meter	Frequency range : 30–300 MHz Measuring range : 0 to ±10 kHz
Audio generator	Frequency range : 300–3000 Hz Output level : 1–500 mV Impedance : 600 Ω	External speaker	Input impedance : 8 Ω Capacity : More than 1 W
		Attenuator	Power attenuation : 30 dB Capacity : More than 10 W

■ SYSTEM REQUIREMENTS (for CS-M34 ADJ ADJUSTMENT SOFTWARE)

- Microsoft® Windows® 98/98SE/Me/2000/XP
- RS-232C serial port (D-sub 9 pin) or USB port

■ ADJUSTMENT SOFTWARE INSTALLATION

- ① Quit all applications when Windows is running.
- ② Insert the CD into the appropriate CD drive.
- ③ Doubleclick the “Setup.exe” contained in the ‘CS-M34 ADJ’ folder in the CD drive.
- ④ The “Welcome to the InstallShield Wizard for CS-M34 ADJ” will appear. Click [Next>].
- ⑤ The “Choose Destination Location” will appear. Then click [Next>] to install the software to the destination folder. (e.g. C:\Program Files\lcom\CS-M34 ADJ)
- ⑥ After the installation is completed, the “InstallShield Wizard Complete” will appear. Then click [Finish].
- ⑦ Eject the CD.
- ⑧ Program group ‘CS-M34 ADJ’ appears in the ‘Programs’ folder of the start menu, and ‘CS-M34 ADJ’ icon appears on the desk top screen.

■ STARTING SOFTWARE ADJUSTMENT

- (1) Connect IC-M33 and a PC with OPC-478/U/UC, OPC-1668 and JIG CABLE.
- (2) Turn the transceiver ON.
- (3) Boot up Windows®, and click the program group ‘CS-M34 ADJ’ in the ‘Programs’ folder of the [Start] menu, then CS-M34 ADJ’s window appears.
- (4) Click ‘Adjust’ on the CS-M34’s window, then IC-M33’s up-to-date condition appears.
- (5) Set or modify adjustment value as specified.

Microsoft and Windows are registered trademarks of Microsoft Corporation in the U.S.A. and other countries.

• CONNECTION

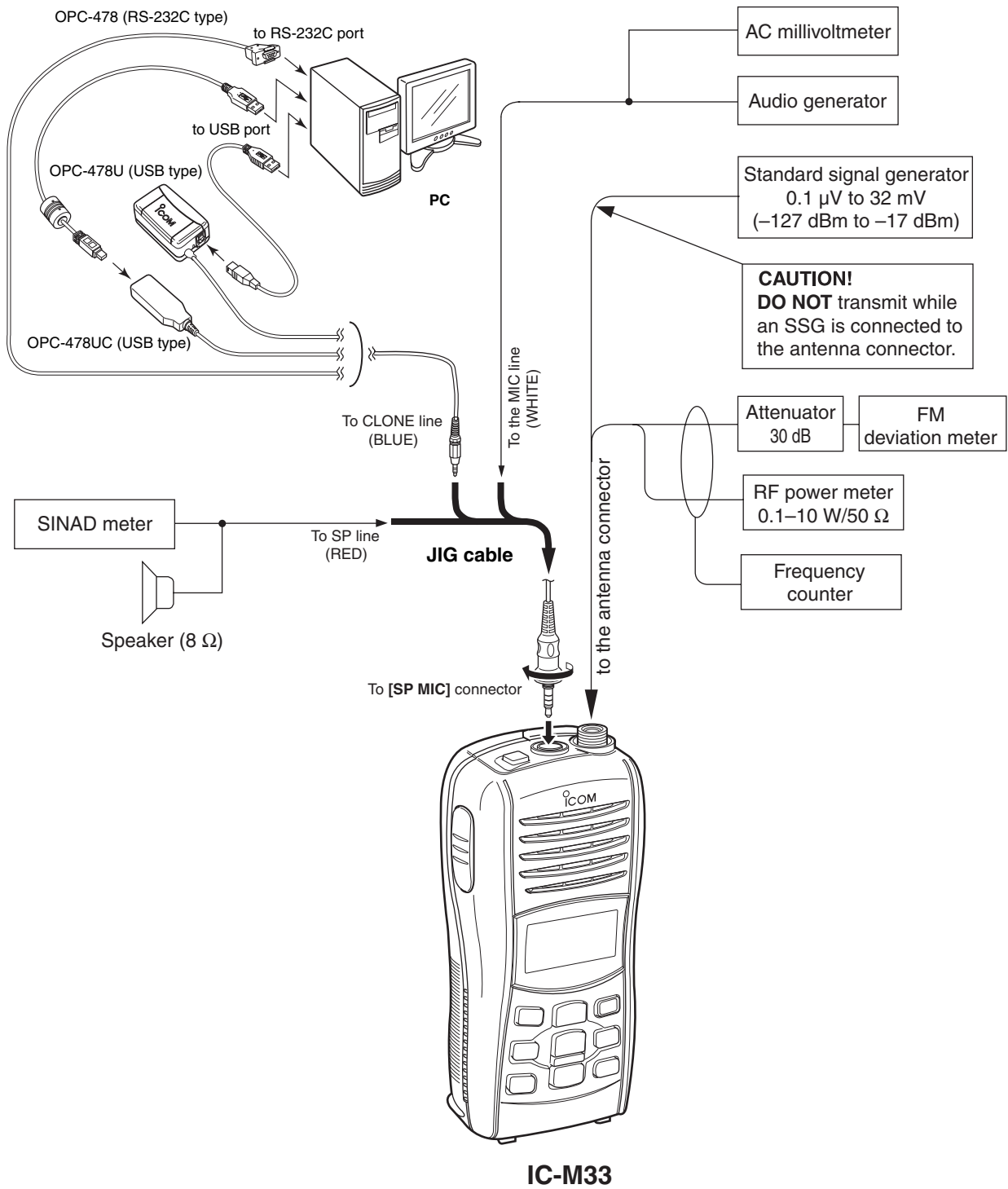

• JIG cable

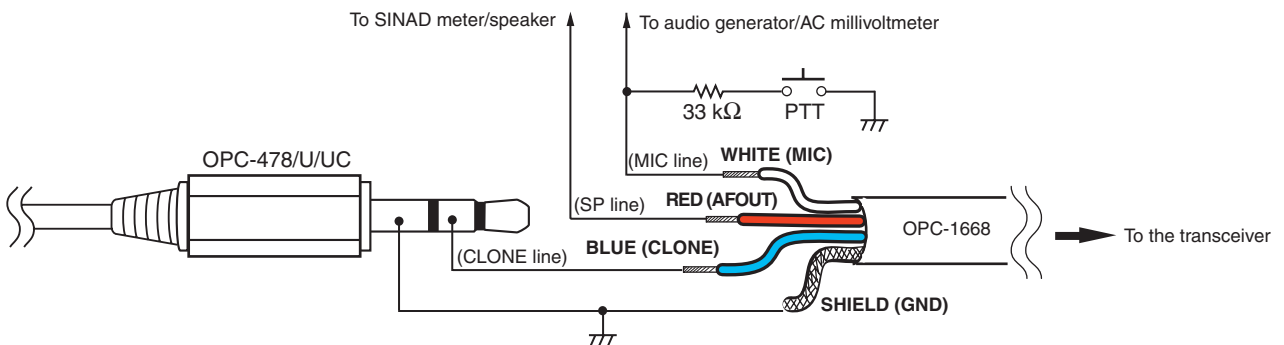

• ADJUSTMENT SOFTWARE SCREEN

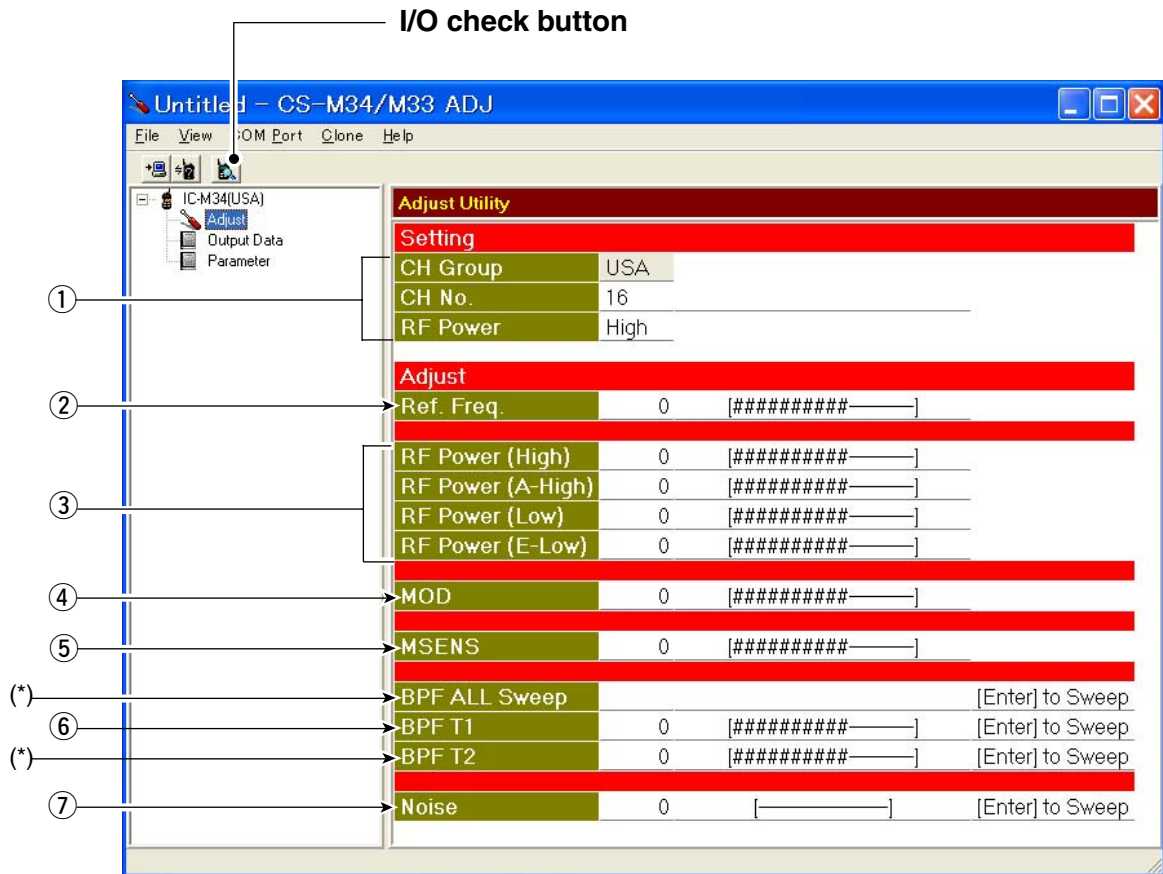

NOTE: The above screen is an example only.
Each transceiver has its own specific values for each setting.

- | | |
|--------------------------|---------------------------|
| ①: Adjustment condition | ⑤: Microphone sensitivity |
| ②: Reference frequency | ⑥: Receive sensitivity |
| ③: Transmit output power | ⑦: Squelch level |
| ④: FM deviation | |

*; **DO NOT** put the cursor on these items and push the [ENTER] key. Otherwise, some adjustment items will not be adjusted properly.

5-2 SOFTWARE ADJUSTMENT (FREQUENCY)

Select an adjustment item using [↑] / [↓] keys, then set to the specified value using [←] / [→] keys on the connected PC's keyboard.

ADJUSTMENT	ADJUSTMENT CONDITION	OPERATION	VALUE
PLL LOCK VOLTAGE (Verify)	1 <ul style="list-style-type: none"> • Operating CH. : 16 • Receiving 	Click the "I/O check button" on the CS-M34 ADJ's screen (see page 5-3) to open the I/O check window as below.	1.3–2.3 V (Verify)
	2 <ul style="list-style-type: none"> • Operating CH. : 16 • RF power : Low • Connect an RF power meter to the antenna connector. • Transmitting 		1.25–2.25 V (Verify)
REFERENCE FREQUENCY [Ref. Freq.]	1 <ul style="list-style-type: none"> • Operating CH. : 16 • RF power : Low • Connect an RF power meter to the antenna connector. • Transmitting 	Loosely couple a frequency counter to the antenna connector.	156.8000 MHz

• I/O CHECK WINDOW

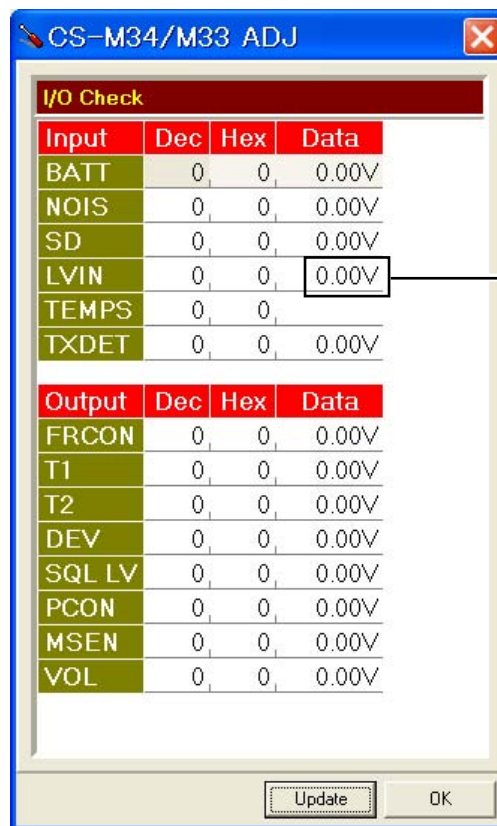

PLL LOCK VOLTAGE will be appeared here

NOTE: The above screen is an example only.
Each item's voltage will appear when clicking [Update] button.

5-3 SOFTWARE ADJUSTMENT (TRANSMIT and RECEIVE)

Select an adjustment item using [↑] / [↓] keys, then set to the specified value using [←] / [→] keys on the connected PC's keyboard.

ADJUSTMENT	ADJUSTMENT CONDITION	OPERATION	VALUE
TRANSMIT OUTPUT POWER [RF Power (High)] (except [FRG])	1 <ul style="list-style-type: none"> • Operating CH. : 16 • RF power : High • Transmitting 	Connect an RF power meter to the antenna connector.	5.0 W [ohters] 4.7 W [AUS]
[RF Power (A-High)] (except [FRG])	2 <ul style="list-style-type: none"> • Operating CH. : 16 • RF power : A-High • Transmitting 		2.0 W
[RF Power (Low)]	3 <ul style="list-style-type: none"> • Operating CH. : 16 • RF power : Low except [FRG] High [FRG] • Transmitting 		0.75 W
[RF Power (E-Low)] ([FRG] only)	4 <ul style="list-style-type: none"> • Operating CH. : 16 • RF power : E-Low • Transmitting 		0.5 W
FM DEVIATION [MOD]	1 <ul style="list-style-type: none"> • Operating CH. : 16 • RF power : Low • Set the FM deviation meter as; HPF : OFF LPF : 20 kHz De-emphasis : OFF Detector : (P-P)/2 • Connect an audio generator to the [SP MIC] connector through the JIG cable, and set as; Frequency : 1 kHz Level : 25 mV rms • Transmitting 	Connect an FM deviation meter to the antenna connector through an attenuator.	±4.30 to ±4.40 kHz
RECEIVE SENSITIVITY [BPF T1]	<p>NOTE1: "RECEIVE SENSITIVITY" should be adjusted before "SQUELCH LEVEL." Otherwise, "SQUELCH LEVEL" will not be adjusted properly.</p> <p>NOTE2: DO NOT put the cursor on [BPF ALL] and [BPF2] then push the [ENTER] key. Otherwise, "RECEIVE SENSITIVITY" will not be adjusted properly.</p>		
	1 <ul style="list-style-type: none"> • Operating CH. : 16 • Connect an SSG to the antenna connector and set as; Frequency : 156.8000 MHz Level : 20 dBμ* (-87 dBm) Modulation : 1 kHz Deviation : ±3.0 kHz • Receiving 	Put the cursor on the [BPF T1], and push the [ENTER] key on the keyboard of the connected PC.	Automatic adjustment
SQUELCH LEVEL [Noise]	1 <ul style="list-style-type: none"> • Operating CH. : 16 • Connect an SSG to the antenna connector and set as; Frequency : 156.8000 MHz Level : -4dBμ* (-111 dBm) Modulation : 1 kHz Deviation : ±3.0 kHz • Receiving 	Put the cursor on the [Noise], and push the [ENTER] key on the keyboard of the connected PC.	Automatic adjustment

*The output level of the standard signal generator (SSG) is indicated as the SSG's open circuit.

SECTION 6

PARTS LIST

[MAIN UNIT]

REF NO.	ORDER NO.	DESCRIPTION	M.	H/V LOCATION
IC1	1130011671	S.IC MB15E03SLPFV1-G-BND-E1	B	47.8/9.1
IC2	1180002690	S.REG S-812C36AMC-C2Q-T2G	B	42.4/15.8
IC50	1120002830	S.IC NJM2125F-TE1-#FZZB	T	101.6/23.1
IC170	1110003201	S.IC TA31136FNG (EL)	B	77.2/35.7
IC190	1190001350	S.IC M62364FP 600D	B	43.5/26.7
IC200	1110006350	S.IC LM2902PWR	B	52/39.2
IC220	1110005350	S.IC NJM2870F05-TE1-#FZZB	T	94/37.2
IC260	1130011770	S.IC CD4066BPWR	B	41/39
IC280	1110001811	S.IC TA7368FG (5.ER)	T	100.2/36.5
IC340	1130012430	S.IC S-24CS64A01-T8T1G	B	12.2/8.1
IC341	1110005771	S.IC S-80942CNMC-G9CT2G	B	6.1/18.8
IC360	1140013720	S.IC uPD78F0338GC-9EB-A	B	18.5/24.2
Q3	1560000541	S.FET 2SK880-Y (T5RICOM,F)	B	37.7/4.8
Q20	1590003790	S.STR KRC404E RTK/P	B	61.6/13.4
Q22	1530004011	S.STR KTC3770U-C-RTK/P	B	72.2/8.7
Q23	1530002381	S.STR 2SC4215-Y (TE85R,F)	B	66.4/19.1
Q24	1530002381	S.STR 2SC4215-Y (TE85R,F)	B	72.2/20.4
Q25	1530002381	S.STR 2SC4215-Y (TE85R,F)	B	60.6/20.9
Q50	1530004011	S.STR KTC3770U-C-RTK/P	T	80.4/5.9
Q53	1560001241	S.FET RD01MUS1-T113	T	88.7/9.5
Q54	1560001231	S.FET RD07MVS1-T112	T	94.9/9.1
Q90	1580000751	S.FET 3SK294 (TE85L,F)	B	92.1/17.8
Q150	1580000731	S.FET 3SK293 (TE85L,F)	B	83.7/17.9
Q151	1530003890	S.STR KTC3880S-Y-RTK/P	T	79.4/38.2
Q220	1510001090	S.STR KTA2015Y-RTK/P	B	90.1/21.6
Q221	1510001090	S.STR KTA2015Y-RTK/P	B	97.2/21.1
Q222	1510001090	S.STR KTA2015Y-RTK/P	T	96.5/26.3
Q223	1590003790	S.STR KRC404E RTK/P	B	91.8/31.5
Q224	1590003800	S.STR KTC811U-GR-RTK/P	B	95/33.2
Q225	1520000840	S.STR KTA1664Y-RTF/P	B	99.6/35.6
Q226	1510001090	S.STR KTA2015Y-RTK/P	T	93.7/22.3
Q230	1520000840	S.STR KTA1664Y-RTF/P	T	106/31.7
Q231	1590003800	S.STR KTC811U-GR-RTK/P	T	102.2/30.4
Q240	1590003790	S.STR KRC404E RTK/P	B	29.8/32.2
Q250	1590003770	S.STR KRA302E-RTK/P	B	63.4/42.6
Q251	1590003770	S.STR KRA302E-RTK/P	B	64.2/40
Q280	1530003960	S.STR KTC2875-B-RTK/P	T	95.9/30.8
Q350	1590003810	S.STR KRC414E-RTK/P	B	10.1/36.9
Q351	1590003780	S.STR KRA304E-RTK/P	T	104.4/22.9
Q352	1590003790	S.STR KRC404E RTK/P	B	7.5/35
Q353	1550000090	S.FET RSQ035P03TR	T	109.6/34.9
Q354	1590003790	S.STR KRC404E RTK/P	T	114.8/41.8
Q355	1590003790	S.STR KRC404E RTK/P	T	117/40.8
Q356	1590003780	S.STR KRA304E-RTK/P	T	116.6/36.7
Q357	1590003790	S.STR KRC404E RTK/P	T	96.6/24
Q358	1590003790	S.STR KRC404E RTK/P	T	89.7/30
Q360	1590003790	S.STR KRC404E RTK/P	B	24.2/8.8
D1	1750000771	S.VCP HVC376BTRF-E	B	37.9/15.8
D3	1750001340	S.DIO KDS160E RTK/P	B	35.7/8.7
D20	1790001260	S.DIO MA25077-(TX)	B	59.6/11.7
D21	1790001260	S.DIO MA25077-(TX)	B	62.6/15.1
D22	1750000711	S.VCP HVC350BTRF-E	B	69.4/6.5
D23	1750000711	S.VCP HVC350BTRF-E	B	70.7/6.5
D50	1790000620	S.DIO MA77 (TX)	T	80.1/17.6
D51	1790000620	S.DIO MA77 (TX)	T	81.4/20.2
D52	1750000581	S.DIO 1SV307 (TPH3,F)	T	106.7/8.7
D80	1790001670	S.DIO RB706F-40T106	T	109.1/12.5
D90	1750000581	S.DIO 1SV307 (TPH3,F)	B	108/8
D91	1790001670	S.DIO RB706F-40T106	T	103.1/15
D92	1750001190	S.VCP KD214E RTK/P	B	103.5/18.5
D93	1750001190	S.VCP KD214E RTK/P	B	101.6/21.6
D94	1790001621	S.DIO 1SV308 (TPH3,F)	B	107.8/10.6
D130	1750001190	S.VCP KD214E RTK/P	B	89.2/19.5
D131	1750001190	S.VCP KD214E RTK/P	B	87/18.9
D350	1750001180	S.DIO KDS122 RTK/P	B	8.7/39.5
D353	1790001240	S.DIO MA2S728-(TX)	B	104.7/13.2
FI150	2030000350	MLH 21R15AB (FL-368)		
FI151	2030000480	MLH 21R15AB (FL-399)		
FI170	2020002410	CER LTM450FW		
X1	6050011740	S.XTL CR-766 (21.250 MHz)	B	40.3/10.4
X170	6070000300	S.DCR JTBM450CX24	B	69.3/39.8
X360	6050012460	S.XTL CR-834 (SMD-49/7.9872 MHz)	B	7.7/9.4
L1	6200008070	S.COL MLF1608E 6R8K 6.8U	B	55.8/27
L20	6200011021	S.COL ELJRF 82NJFB	B	59.1/18.9
L21	6200003711	S.COL NLV25T-2R7J	B	59.6/8.1
L22	6200009910	S.COL C6342A-88NG-A	B	65.1/8.6
L23	6200011031	S.COL ELJRF R10JFB	B	68.4/17.9
L24	6200011031	S.COL ELJRF R10JFB	B	71/18.4
L25	6200011031	S.COL ELJRF R10JFB	B	62.4/19.3
L26	6200009151	S.COL ELJRE 82NJFA	T	83.7/17.1
L30	6200006981	S.COL ELJRE R10GFA	T	82.5/6.3
L51	6200007001	S.COL ELJRE 82NGFA	T	85/7
L53	6200007690	S.COL LQW2BHN18NJ03L	T	89.1/13.6
L55	6200009240	S.COL 0.20-1.0-7TL 31N	T	98.8/12.9
L56	6200010640	S.COL 0.26-1.0-3TL 8.5N	T	97.7/4.3
L57	6200008230	S.COL 0.30-1.3-5TL 22N	T	100.4/4.4
L58	6200003711	S.COL NLV25T-2R7J	T	105.9/11.9
L80	6200012470	S.COL 0.30-1.7-7TL 45.3N	T	105.3/5

[MAIN UNIT]

REF NO.	ORDER NO.	DESCRIPTION	M.	H/V LOCATION
L81	6200012770	S.COL 0.26-1.1-7TR 24N	B	107.5/4.3
L82	6200012780	S.COL 0.30-1.4-6TL 27.2N	T	110.2/8.9
L90	6200012470	S.COL 0.30-1.7-7TL 45.3N	B	104.8/8.1
L92	6200007750	S.COL LQW2BHN56NJ03L	B	102.9/16.3
L93	6200007750	S.COL LQW2BHN56NJ03L	B	100/16.1
L96	6200007750	S.COL LQW2BHN56NJ03L	B	90.9/20.9
L97	6200007750	S.COL LQW2BHN56NJ03L	B	86.5/15.6
L98	6200003680	S.COL LQH31MNR82M03L	B	80.1/19.7
R1	7510001661	S.TMR NTCG16 4LH 473JT	B	40.1/18.2
R2	7030003940	S.RES ERJ3GEYF 104 V (100 k)	B	37.4/18.2
R3	7030005050	S.RES ERJ2GEJ 103 X (10 k)	B	41.1/19.6
R4	7030005240	S.RES ERJ2GEJ 473 X (47 k)	B	39.6/16.8
R5	7030007280	S.RES ERJ2GEJ 331 X (330)	B	42/6.4
R6	7030005120	S.RES ERJ2GEJ 102 X (1 k)	B	57.6/12.3
R7	7030005240	S.RES ERJ2GEJ 473 X (47 k)	B	58.1/11
R8	7030005010	S.RES ERJ2GEJ 681 X (680)	B	47.3/5.3
R10	7030005000	S.RES ERJ2GEJ 471 X (470)	B	46.1/4.9
R11	7030005120	S.RES ERJ2GEJ 102 X (1 k)	B	35.5/6.3
R12	7030005050	S.RES ERJ2GEJ 103 X (10 k)	B	39.6/4.5
R13	7030005210	S.RES ERJ2GEJ 822 X (8.2 k)	B	35.8/3.8
R20	7030004980	S.RES ERJ2GEJ 101 X (100)	B	59.1/17.3
R22	7030009290	S.RES ERJ2GEJ 562 X (5.6 k)	B	48.2/5.3
R23	7030005120	S.RES ERJ2GEJ 102 X (1 k)	B	60.8/11.5
R24	7030005090	S.RES ERJ2GEJ 104 X (100 k)	B	61.2/17.1
R25	7030005090	S.RES ERJ2GEJ 104 X (100 k)	B	60.8/15.4
R26	7030008010	S.RES ERJ2GEJ 123 X (12 k)	B	70.6/14.1
R27	7030008010	S.RES ERJ2GEJ 123 X (12 k)	B	72.8/10.5
R28	7030009160	S.RES ERJ2GEJ 181 X (180)	B	71/10.5
R29	7030005000	S.RES ERJ2GEJ 471 X (470)	B	69.3/14.5
R30	7030005070	S.RES ERJ2GEJ 683 X (68 k)	B	67.1/17.3
R31	7030005010	S.RES ERJ2GEJ 681 X (680)	B	68.9/16.4
R32	7030005000	S.RES ERJ2GEJ 471 X (470)	B	70.6/17
R33	7030007350	S.RES ERJ2GEJ 393 X (39 k)	B	70.4/20.4
R34	7030005000	S.RES ERJ2GEJ 471 X (470)	B	63.9/17.7
R35	7030005070	S.RES ERJ2GEJ 683 X (68 k)	B	63.4/19.3
R36	7030005120	S.RES ERJ2GEJ 102 X (1 k)	T	79/11.8
R37	7030007270	S.RES ERJ2GEJ 151 X (150)	B	43.2/13.2
R38	7030005050	S.RES ERJ2GEJ 103 X (10 k)	B	34.6/7.5
R39	7030005050	S.RES ERJ2GEJ 103 X (10 k)	B	52.1/8.3
R40	7030005220	S.RES ERJ2GEJ 223 X (22 k)	B	52.8/9.6
R41	7030005050	S.RES ERJ2GEJ 103 X (10 k)	B	53.5/8.3
R42	7030005220	S.RES ERJ2GEJ 223 X (22 k)	B	52.8/10.5
R43	7030005050	S.RES ERJ2GEJ 103 X (10 k)	B	53.1/12.6
R44	7030005220	S.RES ERJ2GEJ 223 X (22 k)	B	52.8/11.4
R45	7030005050	S.RES ERJ2GEJ 103 X (10 k)	B	52.2/12.6
R46	7030005220	S.RES ERJ2GEJ 223 X (22 k)	B	51.3/12.6
R47	7030008410	S.RES ERJ2GEJ 392 X (3.9 k)	B	53.4/18.9
R50	7030005120	S.RES ERJ2GEJ 102 X (1 k)	T	80.7/21.9
R52	7030005040	S.RES ERJ2GEJ 472 X (4.7 k)	T	79.7/10.2
R53	7030004980	S.RES ERJ2GEJ 101 X (100)	T	80.6/11.2
R54	7030007260	S.RES ERJ2GEJ 330 X (33)	T	81.2/8.9
R55	7030007300	S.RES ERJ2GEJ 322 X (3.3 k)	T	79.4/8.1
R56	7030007570	S.RES ERJ2GEJ 122 X (1.2 k)	T	78.1/6.7
R57	7030005570	S.RES ERJ2GEJ 820 X (82)	T	78.1/5.8
R65	7030005100	S.RES ERJ2GEJ 154 X (150 k)	T	98.6/25.4
R66	7030005240	S.RES ERJ2GEJ 473 X (47 k)	T	98.3/23.3
R67	7030005090	S.RES ERJ2GEJ 104 X (100 k)	T	101.1/20.5
R68	7030004980	S.RES ERJ2GEJ 101 X (100)	T	100.5/19.3
R69	7030007340	S.RES ERJ2GEJ 153 X (15 k)	T	86.8/3.6
R70	7030007340	S.RES ERJ2GEJ 153 X (15 k)	T	86.8/27.4
R71	7030004980	S.RES ERJ2GEJ 101 X (100)	T	86.9/5.8
R72	7030004970	S.RES ERJ2GEJ 470 X (47)	T	89.1/15.1
R73	7030005120	S.RES ERJ2GEJ 102 X (1 k)	T	89.1/3.8
R74	7030005050	S.RES ERJ2GEJ 103 X (10 k)	T	88.5/2.7
R75	7030004980	S.RES ERJ2GEJ 101 X (100)	T	91.1/3.8
R76	7030000280	S.RES MCR10EZHJ 150 (151)	T	107.7/16.3
R80	7030003670	S.RES ERJ3GEYJ 823 V (82 k)	B	111.5/8
R81	7030005220	S.RES ERJ2GEJ 223 X (22 k)	T	110.6/14.8
R82	7030005050	S.RES ERJ2GEJ 103 X (10 k)	T	109.5/16.1
R85	7030005050	S.RES ERJ2GEJ 103 X (10 k)	B	106.9/12.9
R90	7030004970	S.RES ERJ2GEJ 470 X (47)	B	105.7/10.5
R91	7030005110	S.RES ERJ2GEJ 224 X (220 k)	B	102.8/21.5
R93	7030005050	S.RES ERJ2GEJ 103 X (10 k)	B	98.8/24.6
R94	7030005110	S.RES ERJ2GEJ 224 X (220 k)	B	100.5/23
R95	7030005090	S.RES ERJ2GEJ 104 X (100 k)	B	94.4/18.2
R96	7030005700	S.RES ERJ2GEJ 274 X (270 k)	B	93.2/15.6
R97	7030005000	S.RES ERJ2GEJ 471 X (470)	B	93.9/20.6
R100	7030010040	S.RES ERJ2GEJ-JPW	T	78.5/9.7
R103	7030005050	S.RES ERJ2GEJ 103 X (10 k)	B	95.3/18.2
R104	7030009270	S.RES ERJ2GEJ 821 X (820)	B	89.1/16
R105	7030005110	S.RES ERJ2GEJ 224 X (220 k)	B	89.4/22
R107	7030005110	S.RES ERJ2GEJ 224 X (220 k)	B	88/21.1
R108	7030010040	S.RES ERJ2GEJ-JPW	B	84.7/19.9
R109	7030005530	S.RES ERJ2GEJ 100 X (10)	B	78.9/15.1
R110	7030008400	S.RES ERJ2GEJ 182 X (1.8 k)	B	79.2/16.3
R111	7030005090	S.RES ERJ2GEJ 104 X (100 k)	B	84.4/15.7
R112	7030003860	S.RES ERJ3GE JPW V	B	105.8/11.7
R113	7030003200	S.RES ERJ3GEYJ 100 V (10)	B	97/21.8
R115	7030007350	S.RES ERJ2GEJ 393 X (39 k)	B	81.9/17.6
R116	7030010040	S.RES ERJ2GEJ-JPW	B	88.2/22.4
R120	7030007290	S.RES ERJ2GEJ 222 X (2.2 k)	T	82/21.6
R121	7030007350	S.RES ERJ2GEJ 393 X (39 k)	B	81.9/16
R122	7030005230	S.RES ERJ2GEJ 334 X (330 k)	B	83.2/15.7
R152	7030005030	S.RES ERJ2GEJ 152 X (1.5 k)	B	83.3/23.4
R153	7030005120	S.RES ERJ2GEJ 102 X (1 k)	T	83.7/38.7
R154	7030005090	S.RES ERJ2GEJ 104 X (100 k)	T	81.6/37.4

M.=Mounted side (T: Mounted on the Top side, B: Mounted on the Bottom side) S.=Surface mount

[MAIN UNIT]

REF NO.	ORDER NO.	DESCRIPTION	M.	H/V LOCATION
R155	7030007290	S.RES ERJ2GEJ 222 X (2.2 k)	T	81.5/34.8
R156	7030005000	S.RES ERJ2GEJ 471 X (470)	T	80.3/36.1
R170	7030009280	S.RES ERJ2GEJ 391 X	T	81.9/33.4
R171	7030005120	S.RES ERJ2GEJ 102 X (1 k)	B	73.8/39.8
R172	7030005000	S.RES ERJ2GEJ 471 X (470)	B	74.4/32.3
R173	7030005030	S.RES ERJ2GEJ 152 X (1.5 k)	B	81.9/37.9
R174	7030005110	S.RES ERJ2GEJ 224 X (220 k)	B	79.3/32.4
R175	7030005600	S.RES ERJ2GEJ 273 X (27 k)	B	77.6/30.8
R176	7030005120	S.RES ERJ2GEJ 102 X (1 k)	B	80.7/30.8
R192	7030009280	S.RES ERJ2GEJ 391 X	B	62.9/27.4
R193	7030005000	S.RES ERJ2GEJ 471 X (470)	B	38.3/26
R194	7030005090	S.RES ERJ2GEJ 104 X (100 k)	B	62.6/28.7
R201	7030007290	S.RES ERJ2GEJ 222 X (2.2 k)	B	47.5/36.2
R202	7030005090	S.RES ERJ2GEJ 104 X (100 k)	B	47.1/38.4
R203	7030005110	S.RES ERJ2GEJ 224 X (220 k)	B	49.3/35.9
R204	7030005040	S.RES ERJ2GEJ 472 X (4.7 k)	B	51.8/35.9
R205	7030005210	S.RES ERJ2GEJ 822 X (8.2 k)	B	55.2/33
R206	7030008290	S.RES ERJ2GEJ 183 X (18 k)	B	51.5/34.6
R207	7030005600	S.RES ERJ2GEJ 273 X (27 k)	B	50.6/35.5
R212	7030005030	S.RES ERJ2GEJ 152 X (1.5 k)	B	56.5/34.6
R213	7030005070	S.RES ERJ2GEJ 683 X (68 k)	B	57.2/32.9
R214	7030007340	S.RES ERJ2GEJ 153 X (15 k)	B	58.5/32.3
R220	7030005050	S.RES ERJ2GEJ 103 X (10 k)	T	90.5/19.7
R221	7030005040	S.RES ERJ2GEJ 472 X (4.7 k)	T	88.3/21.9
R222	7030005050	S.RES ERJ2GEJ 103 X (10 k)	T	97.4/19.2
R223	7030005040	S.RES ERJ2GEJ 472 X (4.7 k)	T	95.4/21.5
R224	7030005050	S.RES ERJ2GEJ 103 X (10 k)	T	94.1/25.9
R225	7030005040	S.RES ERJ2GEJ 472 X (4.7 k)	T	93.3/27.1
R226	7030007290	S.RES ERJ2GEJ 222 X (2.2 k)	B	93.8/31.3
R227	7030005050	S.RES ERJ2GEJ 103 X (10 k)	B	96.4/35.4
R228	7030005220	S.RES ERJ2GEJ 223 X (22 k)	B	93.4/34.9
R230	7030005600	S.RES ERJ2GEJ 273 X (27 k)	B	100.9/28.5
R231	7030005160	S.RES ERJ2GEJ 105 X (1 M)	T	102.2/28.1
R232	7030005120	S.RES ERJ2GEJ 102 X (1 k)	T	102.3/32.7
R233	7030007290	S.RES ERJ2GEJ 222 X (2.2 k)	T	100.5/30.8
R234	7030007300	S.RES ERJ2GEJ 332 X (3.3 k)	T	101.4/32.7
R235	7030005930	S.RES ERJ3GEYF 334 V (330 k)	B	95.2/30.5
R236	7030008090	S.RES ERJ3EKF 1503 V (150 k)	B	95.2/27.4
R237	7030010040	S.RES ERJ2GEJ-JPW	T	108.2/37.5
R240	7030004990	S.RES ERJ2GEJ 221 X (220)	B	32.8/32.9
R241	7030005010	S.RES ERJ2GEJ 681 X (680)	B	31.4/32.5
R242	7030005010	S.RES ERJ2GEJ 681 X (680)	B	32.8/32
R245	7030005120	S.RES ERJ2GEJ 102 X (1 k)	T	112.5/27.5
R246	7030005050	S.RES ERJ2GEJ 103 X (10 k)	T	93.5/20.4
R247	7030005040	S.RES ERJ2GEJ 472 X (4.7 k)	T	91.9/22.3
R250	7030005090	S.RES ERJ2GEJ 104 X (100 k)	B	63.2/44.4
R251	7030008280	S.RES ERJ2GEJ 271 X (270)	B	64.9/36.4
R252	7030005060	S.RES ERJ2GEJ 333 X (33 k)	B	87.9/42.8
R253	7030009290	S.RES ERJ2GEJ 562 X (5.6 k)	B	49.5/43.4
R255	7030005170	S.RES ERJ2GEJ 474 X (470 k)	B	49.5/42.5
R256	7030008290	S.RES ERJ2GEJ 183 X (18 k)	B	47.1/39.4
R257	7030005040	S.RES ERJ2GEJ 472 X (4.7 k)	B	47.8/43.8
R258	7030005040	S.RES ERJ2GEJ 472 X (4.7 k)	B	47.8/42
R260	7030008010	S.RES ERJ2GEJ 123 X (12 k)	B	65.1/34.5
R261	7030008410	S.RES ERJ2GEJ 392 X (3.9 k)	B	64.2/34.5
R262	7030008400	S.RES ERJ2GEJ 182 X (1.8 k)	B	67.9/31
R263	7030005090	S.RES ERJ2GEJ 104 X (100 k)	B	45.9/38.8
R264	7030005090	S.RES ERJ2GEJ 104 X (100 k)	B	38.6/43.2
R265	7030005090	S.RES ERJ2GEJ 104 X (100 k)	B	41.7/35.5
R270	7030005050	S.RES ERJ2GEJ 103 X (10 k)	B	88.3/44.1
R271	7030005060	S.RES ERJ2GEJ 333 X (33 k)	B	60.4/41.5
R272	7030005310	S.RES ERJ2GEJ 124 X (120 k)	B	58.8/41.5
R273	7030005220	S.RES ERJ2GEJ 223 X (22 k)	B	58.8/40.5
R274	7030006610	S.RES ERJ2GEJ 394 X (390 k)	B	59.7/36.4
R275	7030005050	S.RES ERJ2GEJ 103 X (10 k)	B	60.1/37.7
R276	7030008300	S.RES ERJ2GEJ 184 X (180 k)	B	58.4/39.5
R277	7030005090	S.RES ERJ2GEJ 104 X (100 k)	B	58/38.3
R278	7030005120	S.RES ERJ2GEJ 102 X (1 k)	B	56.5/41.6
R279	7030005030	S.RES ERJ2GEJ 152 X (1.5 k)	B	57.5/42.5
R281	7030005060	S.RES ERJ2GEJ 333 X (33 k)	T	92.1/29.4
R282	7030005050	S.RES ERJ2GEJ 103 X (10 k)	T	93.9/29.9
R283	7030007260	S.RES ERJ2GEJ 330 X (33)	T	104.8/35
R284	7030005530	S.RES ERJ2GEJ 100 X (10)	B	105.6/42.7
R286	7030005050	S.RES ERJ2GEJ 103 X (10 k)	T	97.1/33
R288	7030005110	S.RES ERJ2GEJ 224 X (220 k)	T	91.2/28.9
R289	7030005090	S.RES ERJ2GEJ 104 X (100 k)	T	95.5/33
R300	7030005290	S.RES ERJ2GEJ 682 X (6.8 k)	B	54/33.6
R304	7030010040	S.RES ERJ2GEJ-JPW	B	9.9/17.4
R340	7030005090	S.RES ERJ2GEJ 104 X (100 k)	B	12.2/12.5
R341	7030005050	S.RES ERJ2GEJ 103 X (10 k)	B	12.2/13.5
R343	7030005050	S.RES ERJ2GEJ 103 X (10 k)	B	8.4/19
R345	7030005170	S.RES ERJ2GEJ 474 X (470 k)	B	21.8/44.3
R346	7030005090	S.RES ERJ2GEJ 104 X (100 k)	B	10.9/39.5
R351	7030005120	S.RES ERJ2GEJ 102 X (1 k)	B	9.8/34.9
R352	7030007340	S.RES ERJ2GEJ 153 X (15 k)	B	11.1/35
R353	7030005120	S.RES ERJ2GEJ 102 X (1 k)	B	11.9/36.5
R361	7030005120	S.RES ERJ2GEJ 102 X (1 k)	B	15.8/8.9
R363	7030005120	S.RES ERJ2GEJ 102 X (1 k)	B	14.9/11.5
R364	7030005050	S.RES ERJ2GEJ 103 X (10 k)	B	16.7/10.7
R367	7030010040	S.RES ERJ2GEJ-JPW [FRG] only	B	23.6/13.1
R371	7030005170	S.RES ERJ2GEJ 474 X (470 k)	B	8.6/33.7
R372	7030007060	S.RES ERJ2GEJ 684X (680 k)	B	7/32.6
R373	7030007310	S.RES ERJ2GEJ 155 X (1.5 M)	B	8.2/32.1
R374	7030009150	S.RES ERJ2GEJ 824 X (820 k)	B	9.1/32.1
R376	7030005090	S.RES ERJ2GEJ 104 X (100 k)	B	49.3/34.9
R377	7030005080	S.RES ERJ2GEJ 823 X (82 k)	B	52.8/34.9
R378	7030005080	S.RES ERJ2GEJ 823 X (82 k)	B	55.2/34.9
R379	7030005080	S.RES ERJ2GEJ 823 X (82 k)	B	56.5/37
R380	7030003580	S.RES ERJ3GEYJ 153 V (15 k)	T	105/10.2
R381	7030005050	S.RES ERJ2GEJ 103 X (10 k)	T	102.4/20
R382	7030009140	S.RES ERJ2GEJ 272 X (2.7 k)	T	104/20.2
R383	7030008010	S.RES ERJ2GEJ 123 X (12 k)	T	103/18.8
R384	7030007290	S.RES ERJ2GEJ 222 X (2.2 k)	T	102.4/20.9
R386	7030005050	S.RES ERJ2GEJ 103 X (10 k)	T	104.4/25.8

[MAIN UNIT]

REF NO.	ORDER NO.	DESCRIPTION	M.	H/V LOCATION
R387	7030005090	S.RES ERJ2GEJ 104 X (100 k)	B	63.7/37.4
R388	7030005170	S.RES ERJ2GEJ 474 X (470 k)	B	46.3/41.3
R390	7030005090	S.RES ERJ2GEJ 104 X (100 k)	B	42.7/35.5
R391	7030005240	S.RES ERJ2GEJ 473 X (47 k)	B	57.7/35
R392	7030010040	S.RES ERJ2GEJ-JPW	B	72.1/32
R394	7030005090	S.RES ERJ2GEJ 104 X (100 k)	B	12.5/35.3
R395	7030005090	S.RES ERJ2GEJ 104 X (100 k)	B	11.1/34.1
R396	7030005050	S.RES ERJ2GEJ 103 X (10 k)	B	14.6/43
R397	7030005700	S.RES ERJ2GEJ 274 X (270 k)	T	111.8/35
R398	7030005050	S.RES ERJ2GEJ 103 X (10 k)	T	110.8/32.1
R399	7030005230	S.RES ERJ2GEJ 334 X (330 k)	T	116.8/39.3
R400	7030005100	S.RES ERJ2GEJ 154 X (150 k)	T	114/40.3
R401	7030005070	S.RES ERJ2GEJ 683 X (68 k)	T	98.6/24.5
R402	7030005050	S.RES ERJ2GEJ 103 X (10 k)	T	91.2/30.5
R403	7030010040	S.RES ERJ2GEJ-JPW	B	20.8/41.9
R422	7030010040	S.RES ERJ2GEJ-JPW	B	12.5/37.7
R423	7030010040	S.RES ERJ2GEJ-JPW	B	40.4/43.2
R426	7030010040	S.RES ERJ2GEJ-JPW [EUR], [HOL] only	B	22.9/11.6
R427	7030010040	S.RES ERJ2GEJ-JPW [UK], [HOL], [AUS] only	B	22/11.6
C1	4030016930	S.CER ECJ0EB1A104K	B	39.2/19.6
C2	4030016790	S.CER ECJ0EB1C103K	B	40.1/19.6
C3	4030017440	S.CER ECJ0EC1H221J	B	39.6/15.2
C4	4030017390	S.CER ECJ0EC1H180J	B	38.3/14.6
C5	4030017640	S.CER ECJ0EC1H150J	B	39.8/6.4
C6	4030017460	S.CER ECJ0EB1E102K	B	58.5/12.3
C7	4030016790	S.CER ECJ0EB1C103K	B	44.5/12.4
C8	4030017350	S.CER ECJ0EC1H020B	B	58.2/26.4
C9	4030017350	S.CER ECJ0EC1H020B	B	58.2/27.6
C11	4550007480	S.TAN F930J106MAABMA	B	41.2/3
C12	4030017460	S.CER ECJ0EB1E102K	B	56/29.2
C13	4030016930	S.CER ECJ0EB1A104K	B	46.9/3.9
C15	4030017460	S.CER ECJ0EB1E102K	B	33.4/6.9
C16	4030017460	S.CER ECJ0EB1E102K	B	39.6/2.9
C17	4030017460	S.CER ECJ0EB1E102K	B	34.9/3.8
C20	4030017460	S.CER ECJ0EB1E102K	B	57.9/16.9
C21	4030017610	S.CER ECJ0EC1H090C	B	57.8/18.5
C22	4030017610	S.CER ECJ0EC1H090C	B	57.8/19.5
C24	4550007620	S.TAN F931V224MAABMA	B	51.2/5
C25	4030017460	S.CER ECJ0EB1E102K	B	60.6/6.3
C26	4030018010	S.CER ECJ0EC1H360J	B	60.3/9.9
C27	4030018010	S.CER ECJ0EC1H360J	B	58.6/9.9
C28	4030017460	S.CER ECJ0EB1E102K	B	58.9/14.6
C29	4030017460	S.CER ECJ0EB1E102K	B	59.4/13.6
C30	4030017460	S.CER ECJ0EB1E102K	B	62.2/16.2
C31	4030017460	S.CER ECJ0EB1E102K	B	70.6/15.1
C32	4030017550	S.CER ECJ0EC1H1R5B	B	69.4/10.3
C33	4030017440	S.CER ECJ0EC1H221J	B	72.4/12.8
C34	4030017550	S.CER ECJ0EC1H1R5B	B	72.1/6.9
C35	4030017460	S.CER ECJ0EB1E102K	B	72.8/11.5
C36	4030017460	S.CER ECJ0EB1E102K	B	67.1/16.4
C37	4030017520	S.CER ECJ0EC1H0R3B	B	68.1/14.5
C38	4030017460	S.CER ECJ0EB1E102K	B	69.4/20.4
C39	4030017630	S.CER ECJ0EC1H120J	B	68.4/19.6
C40	4030017640	S.CER ECJ0EC1H150J	B	72.8/18.4
C41	4030017460	S.CER ECJ0EB1E102K	B	62.4/21
C42	4030017380	S.CER ECJ0EC1H050B	B	63.8/20.8
C43	4030017400	S.CER ECJ0EC1H220J	B	60.5/18.9
C44	4030017460	S.CER ECJ0EB1E102K	T	77.3/11.9
C50	4030017460	S.CER ECJ0EB1E102K	T	80.8/12.1
C51	4030017400	S.CER ECJ0EC1H220J	T	78.5/8.7
C52	4030017460	S.CER ECJ0EB1E102K	T	80.3/8.1
C53	4030017460	S.CER ECJ0EB1E102K	T	78.1/4.9
C54	4030017640	S.CER ECJ0EC1H150J	T	84/5.7
C55	4030017410	S.CER ECJ0EC1H240J	T	84.4/4.4
C56	4030016790	S.CER ECJ0EB1C103K	T	99.2/23.3
C57	4030016930	S.CER ECJ0EB1A104K	T	102.4/25.9
C58	4030016930	S.CER ECJ0EB1A104K	T	100.2/20.5
C59	4030017730	S.CER ECJ0EB1E471K	T	101.7/18.8
C60	4030017460	S.CER ECJ0EB1E102K	T	99.3/20.5
C61	4510008570	S.ELE EEE1CA220SR	B	107.6/17
C62	4030017460	S.CER ECJ0EB1E102K	T	101.3/16.2
C63	4030006860	S.CER C1608 JB 1H 102K-T	T	86.8/12.5
C63	4030017730	S.CER ECJ0EB1E471K	T	86.8/12.5
C64	4030017460	S.CER ECJ0EB1E102K	T	88.3/5.3
C65	4030017430	S.CER ECJ0EC1H101J	T	91.1/5.4
C66	4030017460	S.CER ECJ0EB1E102K	T	90.6/2.6
C67	4030017730	S.CER ECJ0EB1E471K	T	101/13.9
C68	4030017420	S.CER ECJ0EC1H470J	T	98.6/14.9
C70	4030018020	S.CER C1608 CH 1H 910J-T	T	98.1/1.8
C71	4030008560	S.CER C1608 CH 1H 300J-T	T	102.7/3
C72	4030006860	S.CER C1608 JB 1H 102K-T	T	102.7/5.6
C73	4030017460	S.CER EC		

[MAIN UNIT]

REF NO.	ORDER NO.	DESCRIPTION	M.	H/V LOCATION
C95	4030017400	S.CER ECJ0EC1H220J	B	102.3/18.4
C96	4030017460	S.CER ECJ0EB1E102K	B	98.8/23
C97	4030017360	S.CER ECJ0EC1H030B	B	102.7/14.8
C98	4030017350	S.CER ECJ0EC1H020B	B	103.4/20.2
C99	4030017650	S.CER ECJ0EC1H270J	B	100.5/21.4
C100	4030017360	S.CER ECJ0EC1H030B	B	101.4/18.4
C101	4030017620	S.CER ECJ0EC1H100C	B	98.9/18.5
C102	4030016790	S.CER ECJ0EB1C103K	B	92.7/19.6
C103	4030017420	S.CER ECJ0EC1H470J	B	92.7/20.5
C104	4030016790	S.CER ECJ0EB1C103K	B	92.4/21.7
C109	4030017460	S.CER ECJ0EB1E102K	B	89.7/17.8
C110	4030017660	S.CER ECJ0EC1H330J	B	88.1/19.5
C111	4030017460	S.CER ECJ0EB1E102K	B	86.7/21.5
C112	4030017360	S.CER ECJ0EC1H030B	B	89.1/15
C113	4030017540	S.CER ECJ0EC1HR75B	B	88.8/16.9
C114	4030017420	S.CER ECJ0EC1H470J	B	86.7/20.6
C115	4030017380	S.CER ECJ0EC1H050B	B	87/17.1
C116	4030017570	S.CER ECJ0EC1H040B	B	85.8/17.5
C117	4030017560	S.CER ECJ0EC1H2R5B	B	101.8/19.7
C119	4030017500	S.CER ECJ0EB1E102K	B	79.2/18.1
C120	4030016970	S.CER ECJ0EB1C223K	B	78/15.1
C121	4030017460	S.CER ECJ0EB1E102K	B	79.2/21.3
C122	4030017460	S.CER ECJ0EB1E102K	T	83.7/19.3
C123	4030017460	S.CER ECJ0EB1E102K	T	81.5/16.2
C125	4030016930	S.CER ECJ0EB1A104K	B	44.7/16.3
C126	4030017460	S.CER ECJ0EB1E102K	B	49/12.4
C127	4030017420	S.CER ECJ0EC1H470J	B	34.6/9.1
C128	4030017730	S.CER ECJ0EB1E471K	B	33.7/10.2
C129	4030016930	S.CER ECJ0EB1A104K	B	33.4/8
C131	4030018120	S.CER ECJ0EC1H110J	T	82.6/16.3
C132	4030017460	S.CER ECJ0EB1E102K	B	42.4/18.2
C133	4030017460	S.CER ECJ0EB1E102K	B	53.4/20.2
C134	4030017590	S.CER ECJ0EC1H070C	B	79.2/17.2
C154	4030017460	S.CER ECJ0EB1E102K	B	82.5/21.6
C155	4030017580	S.CER ECJ0EC1H060C	T	85.2/30.5
C156	4030017460	S.CER ECJ0EB1E102K	T	82/38.7
C157	4030016970	S.CER ECJ0EB1C223K	T	80.5/34.8
C158	4030017460	S.CER ECJ0EB1E102K	T	82/36.1
C159	4030016790	S.CER ECJ0EB1C103K	T	77.9/36.7
C160	4030018240	S.CER ECJ0EB1E562K	T	81.9/32.4
C170	4030017460	S.CER ECJ0EB1E102K	B	78.6/39.4
C171	4030017680	S.CER ECJ0EC1H820J	B	72.8/34.6
C174	4030017460	S.CER ECJ0EB1E102K	B	76.1/32.4
C176	4030017460	S.CER ECJ0EB1E102K	B	73.1/31.9
C177	4030016930	S.CER ECJ0EB1A104K	B	82.1/36.7
C178	4030018890	S.CER ECJ0EB0J224K	B	83.5/36.2
C179	4030017720	S.CER ECJ0EB1H331K	B	79.3/31.5
C180	4030017720	S.CER ECJ0EB1H331K	B	80.5/32.3
C181	4030016930	S.CER ECJ0EB1A104K	B	78.1/32.1
C191	4030016790	S.CER ECJ0EB1C103K	B	63.3/36.4
C192	4510008540	S.ELE EEE1CA100SR	B	66.8/28.1
C193	4030016790	S.CER ECJ0EB1C103K	B	38.1/24.3
C194	4030016790	S.CER ECJ0EB1C103K	B	48.7/26.8
C200	4030016790	S.CER ECJ0EB1C103K	B	51.8/42.9
C202	4030016930	S.CER ECJ0EB1A104K	B	52.8/34
C205	4030016960	S.CER ECJ0EB1C183K	B	57.7/34.1
C206	4030017460	S.CER ECJ0EB1E102K	B	58.5/33.2
C207	4030016930	S.CER ECJ0EB1A104K	B	58.5/31.4
C220	4510008660	S.ELE EEEJA220SR	B	91/27.2
C221	4030016790	S.CER ECJ0EB1C103K	T	88.3/20.3
C222	4030016790	S.CER ECJ0EB1C103K	T	95.5/19.7
C223	4030016790	S.CER ECJ0EB1C103K	T	94.6/27.5
C224	4510008660	S.ELE EEEJA220SR	B	98.3/29.9
C225	4030018890	S.CER ECJ0EB0J224K	B	93/33
C226	4030016790	S.CER ECJ0EB1C103K	T	91.8/38
C227	4550007090	S.TAN TEESVA 1A 226M8R	B	92.9/38
C228	4030017460	S.CER ECJ0EB1E102K	T	93.6/34.9
C229	4030017460	S.CER ECJ0EB1E102K	T	108.2/39.1
C230	4550007500	S.TAN F931D106MBA BMA	T	110.4/39.6
C231	4030018860	S.CER ECJ0EB0J105K	T	103.1/28.1
C232	4030016930	S.CER ECJ0EB1A104K	T	100.5/32.4
C233	4030016790	S.CER ECJ0EB1C103K	B	94.1/27.9
C234	4030016790	S.CER ECJ0EB1C103K	T	91.9/20.7
C240	4030017460	S.CER ECJ0EB1E102K	T	109/29.6
C250	4030016930	S.CER ECJ0EB1A104K	B	64.1/44.4
C251	4510008540	S.ELE EEE1CA100SR	B	68.7/33.9
C252	4030017460	S.CER ECJ0EB1E102K	B	88.8/42.8
C254	4030016930	S.CER ECJ0EB1A104K	B	47.8/42.9
C257	4030016790	S.CER ECJ0EB1C103K	B	50.8/42.9
C260	4510008540	S.ELE EEE1CA100SR	B	72.8/28
C261	4030018890	S.CER ECJ0EB0J224K	B	46.3/40.4
C262	4030016790	S.CER ECJ0EB1C103K	B	43.8/35.5
C263	4030016790	S.CER ECJ0EB1C103K	B	58.9/38.3
C264	4030018240	S.CER ECJ0EB1E562K	B	60.4/40
C265	4030017430	S.CER ECJ0EC1H101J	B	57.5/40.9
C266	4030017030	S.CER ECJ0EB1A273K	B	58.6/44.1
C280	4030018900	S.CER ECJ0EB0J474K	T	97.9/31.1
C281	4030018900	S.CER ECJ0EB0J474K	T	93/29.9
C282	4510008540	S.ELE EEE1CA100SR	B	103.3/30.1
C283	4030016930	S.CER ECJ0EB1A104K	T	99.3/31.6
C284	4030017460	S.CER ECJ0EB1E102K	T	99.3/30.7
C285	4030016930	S.CER ECJ0EB1A104K	T	95.5/33.9
C286	4550007480	S.TAN F930J106MBA BMA	T	106.6/38.1
C287	4030017700	S.CER ECJ0EC1H151J	T	104.5/36.3
C288	4030016950	S.CER ECJ0EB1A473K	B	104/42.2
C289	4510009010	S.ELE EEE1AA221P	B	107.7/37.8
C300	4030017770	S.CER ECJ0EB1E332K	B	55.2/34
C340	4030016790	S.CER ECJ0EB1C103K	B	14.6/8.8
C341	4030008890	S.CER C1608 JB 1H 273K-T	B	3.5/19.4
C350	4030016790	S.CER ECJ0EB1C103K	B	26.2/16.4
C351	4030017420	S.CER ECJ0EC1H470J	B	8.2/36.5
C352	4030017420	S.CER ECJ0EC1H470J	B	8.2/37.4
C360	4030016790	S.CER ECJ0EB1C103K	B	30.8/20.2
C361	4030016950	S.CER ECJ0EB1A473K	B	6.3/29.6

[MAIN UNIT]

REF NO.	ORDER NO.	DESCRIPTION	M.	H/V LOCATION
C363	4030016950	S.CER ECJ0EB1A473K	B	4.9/26
C364	4030016950	S.CER ECJ0EB1A473K	B	4.4/25.1
C365	4030016950	S.CER ECJ0EB1A473K	B	4.4/24.2
C366	4030016950	S.CER ECJ0EB1A473K	B	4.4/21.5
C367	4030017040	S.CER ECJ0EB1A333K	B	5.7/26.9
C370	4030018070	S.CER ECJ0EC1H300J	B	4.2/8
C371	4030017400	S.CER ECJ0EC1H220J	B	4.2/12.2
C372	4030016930	S.CER ECJ0EB1A104K	B	10.5/40.8
C373	4030018900	S.CER ECJ0EB0J474K	B	7.4/33.5
C374	4030018900	S.CER ECJ0EB0J474K	B	7/30.6
C375	4030018900	S.CER ECJ0EB0J474K	B	7/31.5
C377	4030017740	S.CER ECJ0EB1E821K	B	54/35.3
C378	4030017780	S.CER ECJ0EB1E472K	B	56.1/35.8
C379	4030017420	S.CER ECJ0EC1H470J	B	56.5/38.7
C380	4030017460	S.CER ECJ0EB1E102K	T	103.9/18.8
C381	4030017460	S.CER ECJ0EB1E102K	T	103.5/25.8
C382	4030018860	S.CER ECJ0EB0J105K	B	88.3/45
C383	4030018860	S.CER ECJ0EB0J105K	B	42.9/42.3
C384	4030016930	S.CER ECJ0EB1A104K	B	63.7/38.4
C385	4030016790	S.CER ECJ0EB1C103K	B	46.6/35.2
C386	4030018900	S.CER ECJ0EB0J474K	B	7.7/29.1
C387	4030017460	S.CER ECJ0EB1E102K	B	6.1/28.7
C388	4030016790	S.CER ECJ0EB1C103K	B	28/17.4
C389	4550007520	S.TAN F931A106MAA BMA	B	31.9/18.6
C390	4030017460	S.CER ECJ0EB1E102K	T	109.9/32.1
C391	4030017460	S.CER ECJ0EB1E102K	B	96.4/37.3
C392	4030017460	S.CER ECJ0EB1E102K	T	114/39.4
C393	4030016950	S.CER ECJ0EB1A473K	B	4.4/23.3
C394	4030016950	S.CER ECJ0EB1A473K	B	5.8/27.8
C410	4030017420	S.CER ECJ0EC1H470J	T	109.9/24.3
C411	4030017420	S.CER ECJ0EC1H470J	T	112.3/29.1
C412	4030017420	S.CER ECJ0EC1H470J	T	113.3/25.5
C413	4030017420	S.CER ECJ0EC1H470J	T	109.9/29.3
C414	4030017440	S.CER ECJ0EC1H221J	T	110.9/27.3
C415	4030017440	S.CER ECJ0EC1H221J	T	112.8/30.7
J250	6510025870	CNR PJ-363-2 <BSUN>		
J251	6510021901	S.CNR BM02B-ASRS-TF (LF) (SN)	T	104.5/43.1
J252	6510022691	S.CNR 06FLT-SM2-TB (LF) (SN)	B	17.1/39.7
DS240	5040003230	S.LED RY-SP110UHY24-5M	T	78/32.7
DS241	5040003230	S.LED RY-SP110UHY24-5M	T	78/15.7
DS242	5040002310	S.LED SML-311YTT86	T	15.9/33
DS243	5040002310	S.LED SML-311YTT86	T	29.7/32.2
DS244	5040002310	S.LED SML-311YTT86	T	15.9/15.4
DS245	5040002310	S.LED SML-311YTT86	T	29.7/16.2
DS246	5030003000	LCD S11000 <SUC>		
MC250	7700002710	MIC EM6027P-46C33-G		
S250	2260001900	SW SW-149 (SKHLLD)		
S329	2260002710	S.SW SKQLLCE012	B	116.7/38.3
EP2	6910014690	S.BEA MPZ1608S221A-T	T	86.7/15.1
EP3	6910014690	S.BEA MPZ1608S221A-T	T	100.1/15.8
EP4	6910012350	S.BEA MMZ1608Y 102BT	T	109.2/27.9
EP5	6910012350	S.BEA MMZ1608Y 102BT	T	111.8/23.6
EP6	6910012350	S.BEA MMZ1608Y 102BT	T	114.3/23.6
EP7	6910012350	S.BEA MMZ1608Y 102BT	T	114.6/29.2
EP360	8930057100	LCT SRCN-2497-SP-N-W		

M.=Mounted side (T: Mounted on the Top side, B: Mounted on the Bottom side)
S.=Surface mount

SECTION 7 MECHANICAL PARTS AND DISASSEMBLY

[CHASSIS PARTS]

REF NO.	ORDER NO.	DESCRIPTION	QTY.
J31	6910014190	2497 ANT CONNECTOR	1
SP1	2510001330	036D0803	1
W1	8900016000	OPC-1129A	1
MP1	8210023581	2987 FRONT PANEL (A)-1 (incl. MP2, MP3)	1
MP2	8310068710	2987 WINDOW PLATE (A)	1
MP3	8930011900	Speaker net (A3)	1
MP4	8930068980	2905 VENT SHEET	1
MP5	8930071390	2987 KEYBOARD (A)	1
MP6	8930070930	2987 PTT BUTTON	1
MP7	8930070971	2987 PTT HOLDER-1	1
MP8	8610011151	2497 BATT LOCK-1	1
MP9	8930056941	2497 LOCK PLATE-1	1
MP14	8850001950	Sealing washer (Y)	1
MP15	8830001720	2721 ANT NUT	1
MP16	8930070980	2987 MIC CAP	1
MP17	8930070990	2987 CAP HOLDER	1
MP18	8930070961	2987 MIC SEAL-1	1
MP19	8930071340	2987 WINDOW SHEET	1
MP21	8210023310	2987 REAR PANEL	1
MP22	8930070950	2987 MAIN SEAL	1
MP23	8810010121	ScrewPH B0 2X8 SUS SSBC	2
MP24	8820001320	2795 SCREW	2
MP25	8930063690	O-RING (BA)	2
MP31	8010020660	2987 CHASSIS	1
MP32	8930071320	2987 TERMINAL HOLDER	1
MP33	8810009561	Screw BT B0 2X6 NI-ZK3 (BT)	4
MP34	8930060770	2691 A-TERMINAL	1
MP35	8930056900	2497 B-TERMINAL	1
MP37	8930056910	2497 C-TERMINAL	1
MP39	8810009511	Screw BT B0 2X4 NI-ZC3 (BT)	7
MP42	8810009561	Screw BT B0 2X6 NI-ZK3 (BT)	4
MP43	8510018100	2987 SHIELD PLATE	1
MP46	8930070940	2987 PW BUTTON	1
MP47	8930060790	2691 PW HOLDER	1
MP48	8930030920	1301 SHEET	1
MP50	8930071260	O-RING (BL)	1

[ACCESSORIES]

REF NO.	ORDER NO.	DESCRIPTION	QTY.
EP1	Optional product	FA-SC58V-1	1
EP2	Optional product	BC-174E [EUR], [UK], [FRG]	1
	Optional product	BM-95V [AUS]	1
EP3	Optional product	BP-251-1 [UK] only	1
EP4	Optional product	BP-252	1
EP5	Optional product	BC-173	1
EP6	6910018620	BLACK HANDY STRAP	1
MP2	Optional product	MB-109	1
MP4	8810001460	Screw BT A0 3.5X20 SUS	2

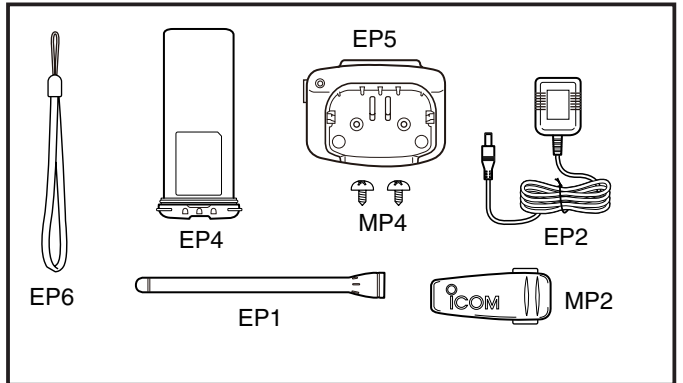

[MAIN UNIT]

REF NO.	ORDER NO.	DESCRIPTION	QTY.
J250	6510025870	PJ-363-2	1
DS246	5030003000	S11000	1
MC250	7700002710	EM6027P-46C33-G	1
S250	2260001900	SW-149 (SKHLLD)	1
EP360	8930057100	SRCN-2497-SP-N-W	1
MP20*	8510014940	2601 VCO CASE	1
MP21	8510014950	2601 VCO COVER	1
MP50*	8410002570	2795 PA HEATSINK	1
MP360	8210023320	2987 REFLECTOR	1
MP361	8930071000	2987 LCD HOLDER	1

*: Refer to SECTION 9 BOARD LAYOUTS.

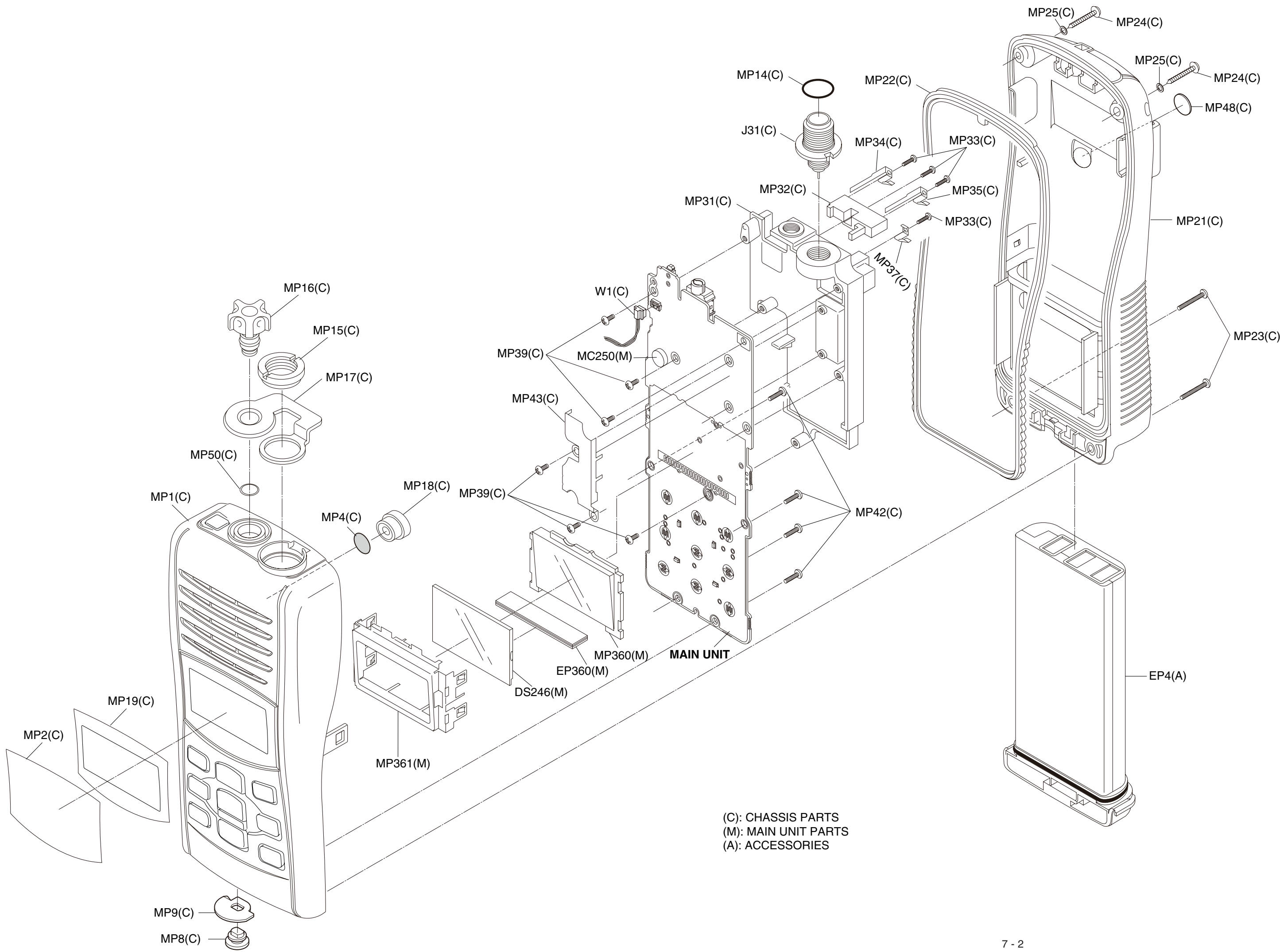







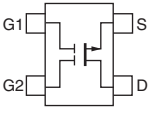
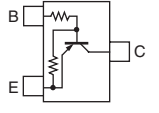
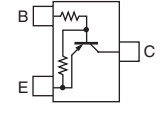
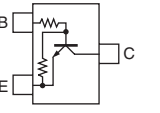
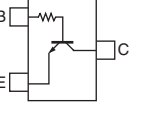
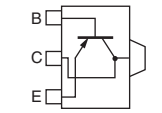
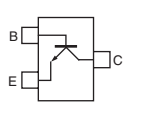
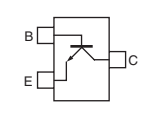
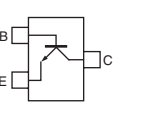
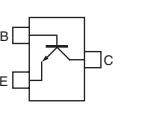
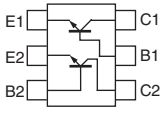
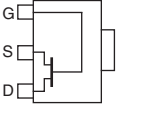
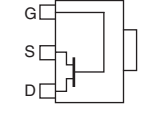
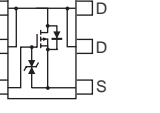

(C): CHASSIS PARTS
(M): MAIN UNIT PARTS
(A): ACCESSORIES

SECTION 8 SEMICONDUCTOR INFORMATION

• TRANSISTERS

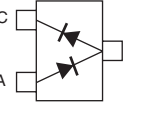
<p>• 3SK294 (Marking: UV)</p> 	<p>• KRA302E (Marking: PB)</p> 	<p>• KRA304E (Marking: PD)</p> 	<p>• KRC404E (Marking: ND)</p> 	<p>• KRC414E (Marking: NP)</p> 
<p>• KTA1664Y (Marking: R)</p> 	<p>• KTA2015Y (Marking: Z)</p> 	<p>• KTC2875 (Marking: M)</p> 	<p>• KTC3770U (Marking: R)</p> 	<p>• KTC3880S (Marking: AQ)</p> 
<p>• KTC811U (Marking: V)</p> 	<p>• RD01MUS1 (Marking: K2)</p> 	<p>• RD07MVS1 (Marking: RD07MVS1)</p> 	<p>• RSQ035P03TR (Marking: TM)</p> 	

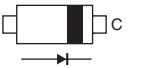
• DIODES

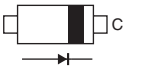
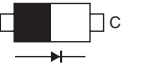
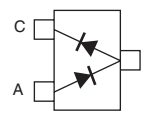
<p>• 1SV307 (Marking: TX)</p> 	<p>• 1SV308 (Marking: TX)</p> 	<p>• HVC350BTRF (Marking: B0)</p> 	<p>• HVC376BTRF (Marking: XX)</p> 	<p>• KDS122 (Marking: C3)</p> 
<p>• KDS160E (Marking: UF)</p> 	<p>• KDV214E (Marking: UO)</p> 	<p>• MA2S077 (Marking: S)</p> 	<p>• MA2S728 (Marking: B)</p> 	<p>• MA77 (Marking: 4B)</p> 
<p>• RB706F (Marking: 3J)</p> 				

The combination of this side and the bottom side shows the board layout in the same configuration as the actual P.C.Board.

• MAIN UNIT (TOP VIEW)

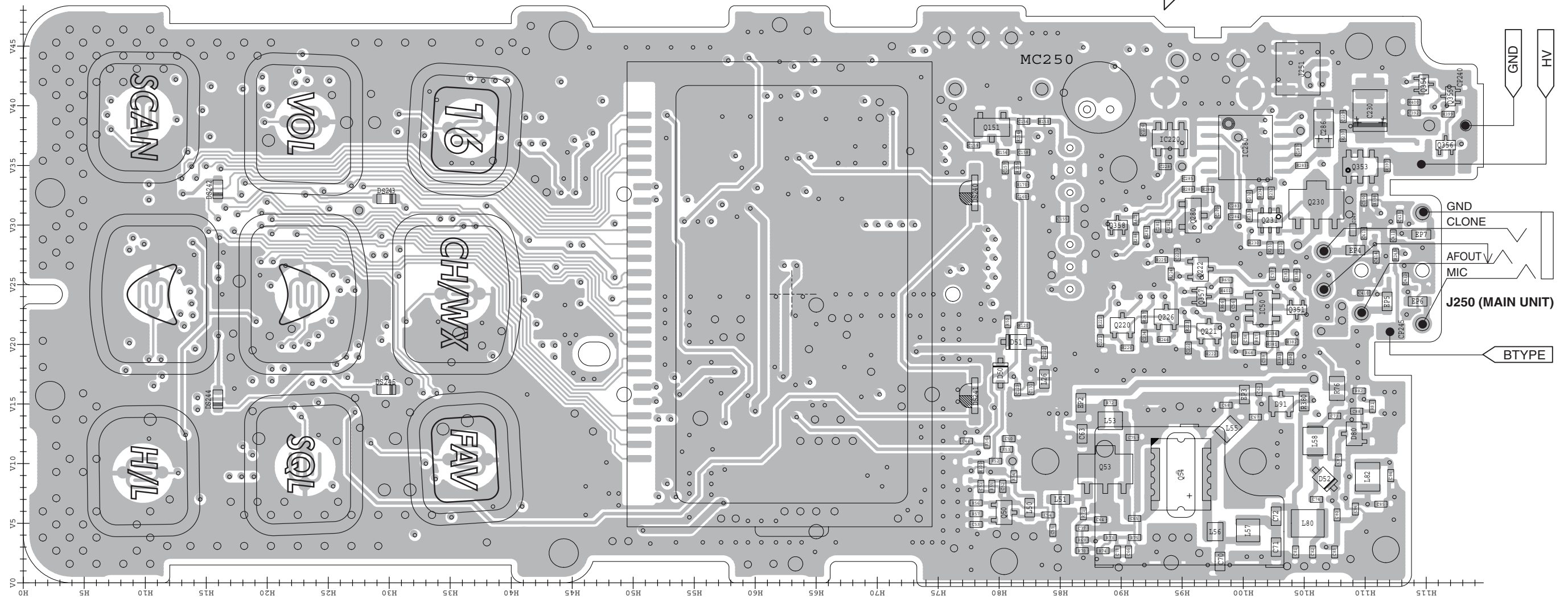

• BC-173 (TOP VIEW)

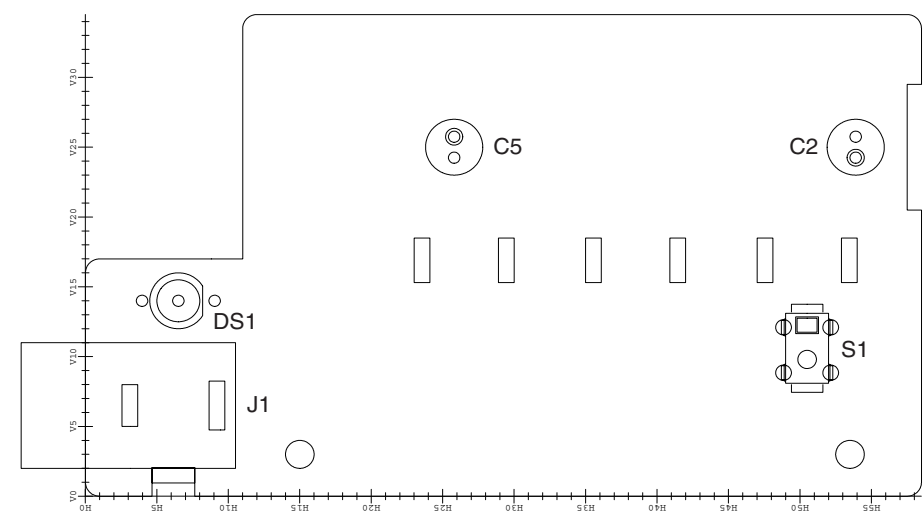

The combination of this side and the bottom side shows the board layout in the same configuration as the actual P.C.Board.

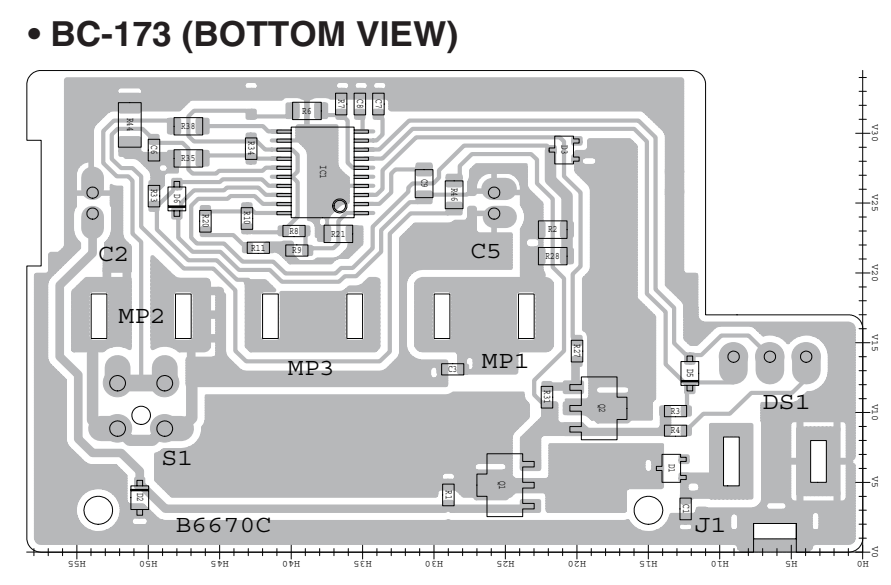
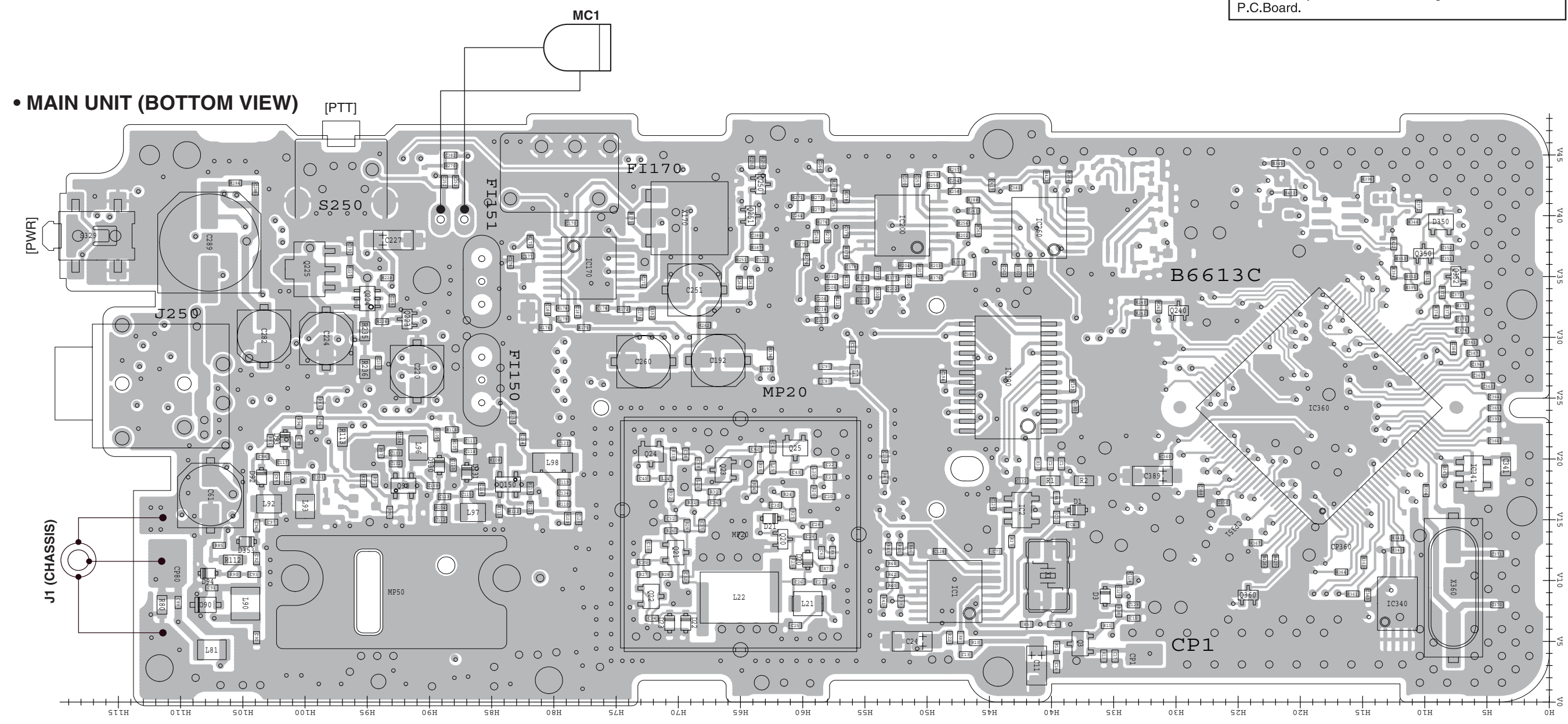

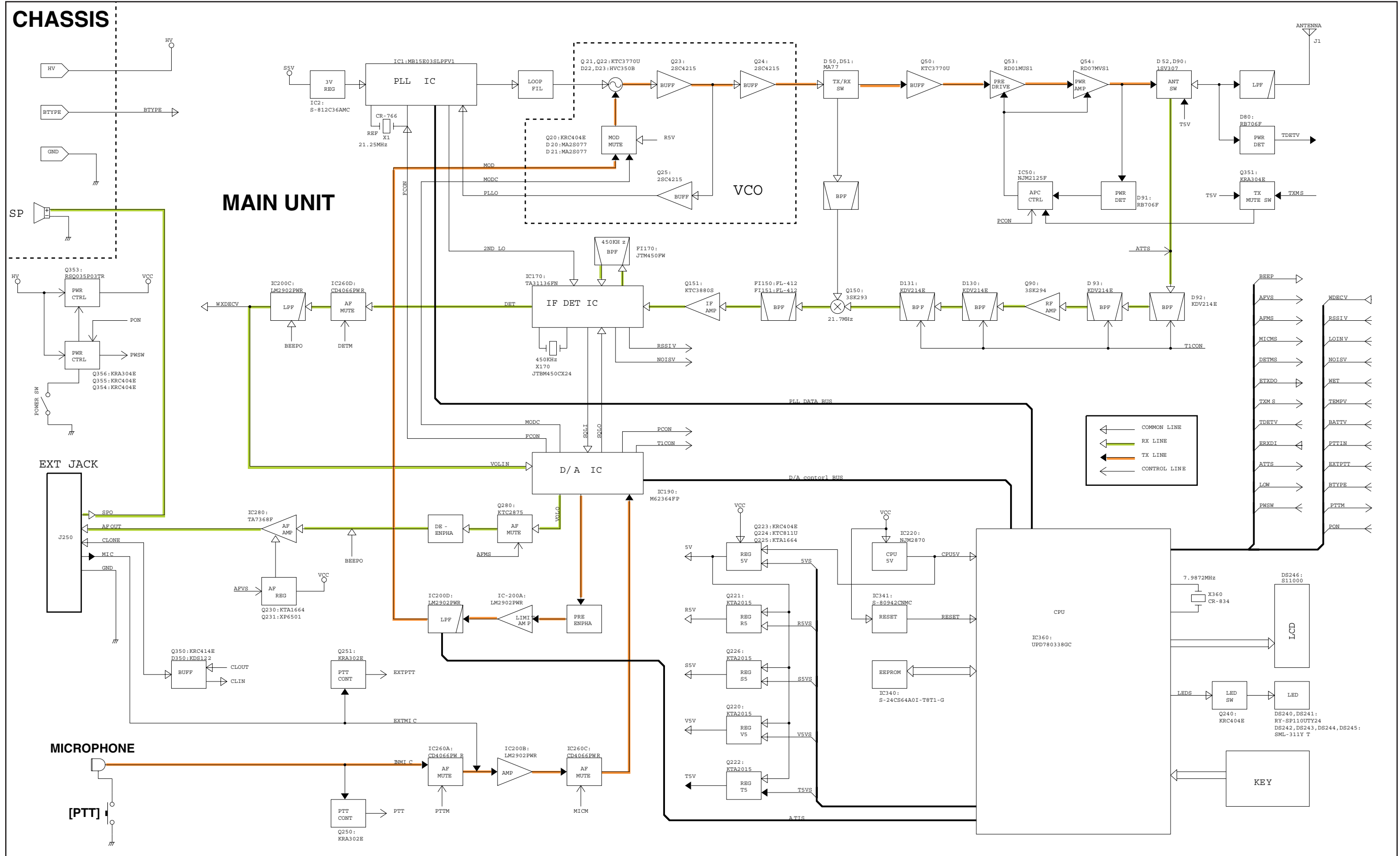

11-2 MAIN UNIT (Right side)

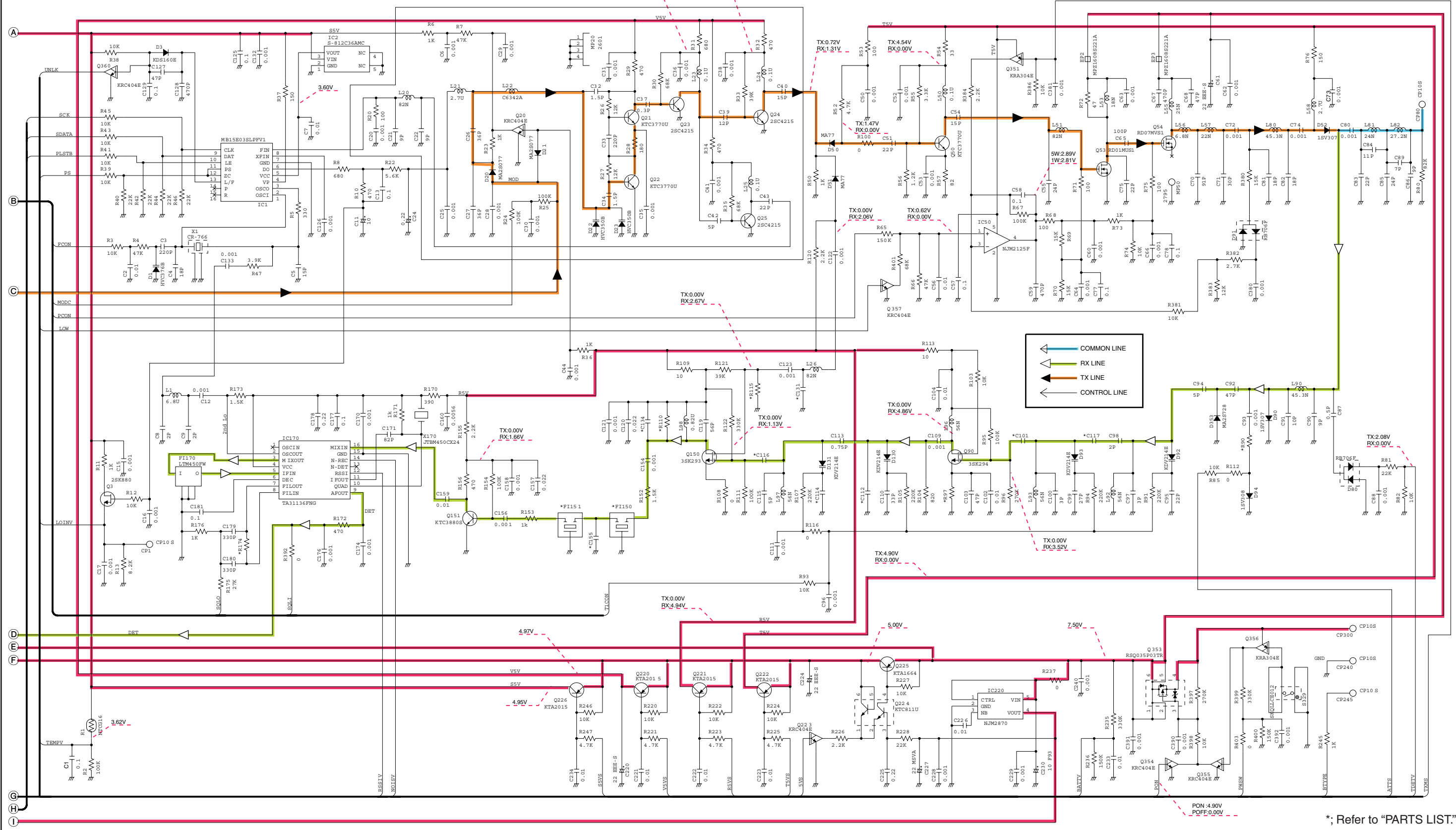

*; Refer to "PARTS LIST."

• MECHANICAL PARTS

[CHASSIS PARTS]

REF NO.	ORDER NO.	DESCRIPTION	QTY.
MP1	8010020650	3002 CASE	1
MP2	8110009030	3002 COVER	1
MP3	8810008661	Screw BT B0 3X8 NI-ZC3 (BT)	2
MP4	8930039620	LEG CUSHION (A)	2

[MAIN UNIT]

REF NO.	ORDER NO.	DESCRIPTION	QTY.
J1	6510024940	HEC2305-016250	1
DS1	5040002740	RT3-03HRYG	1
S1	2230001190	SPPB512300	1
MP1	8930071290	3002 TERMINAL	1
MP2	8930071290	3002 TERMINAL	1
MP3	8930071290	3002 TERMINAL	1

[ACCESSORY]

REF NO.	ORDER NO.	DESCRIPTION	QTY.
MP1	8810001460	Screw BT A0 3.5X20 SUS	2



MP1

• EXPLODED VIEW

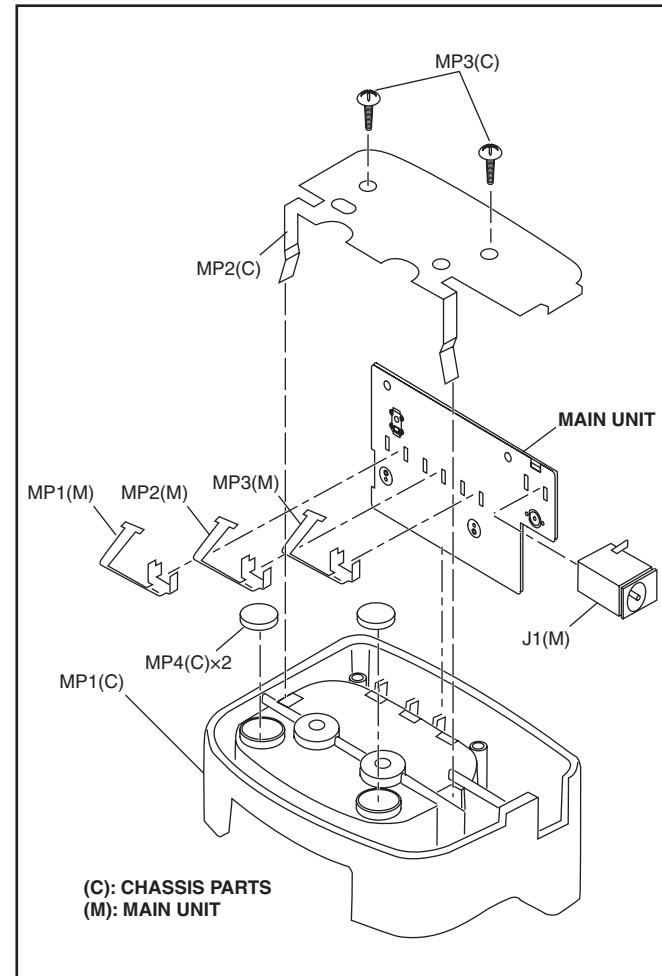

• ELECTRICAL PARTS

[MAIN UNIT]

REF NO.	ORDER NO.	DESCRIPTION	M.	H/V LOCATION
IC1	1190002270	S.IC NJW4100V-TE1	B	37.8/27.2
Q1	1540000550	S.TR 2SD1664 T100Q	B	25/4.8
Q2	1520000460	S.TR 2SB1132 T100 R	B	18.5/10.3
D1	1750001400	S.DIO RB461F-T106	B	13.4/6
D2	1730002710	S.ZEN UDZSTE-17 11B	B	50.6/3.9
D3	1750001400	S.DIO RB461F-T106	B	20.9/28.8
D5	1750000550	S.DIO 1SS355 TE-17	B	12.1/12.8
D6	1750000550	S.DIO 1SS355 TE-17	B	48/25.3
R1	7030002110	S.RES MCR03EZJH 470 (471)	B	29/4.1
R2	7030000020	S.RES MCR10EZJH 1 (010)	B	21.7/23.1
R3	7030002220	S.RES MCR03EZJH 3.3 k	B	13.1/10.1
R4	7030002240	S.RES MCR03EZJH 4.7 k	B	13.1/8.7
R6	7030000500	S.RES MCR10EZJH 10 k	B	38.9/31.6
R7	7030002170	S.RES MCR03EZJH 1.5 k	B	36.5/32.1
R8	7030002280	S.RES MCR03EZJH 10 k	B	39.8/23
R9	7030002150	S.RES MCR03EZJH 1 k	B	39.6/21.6
R10	7030011720	S.RES MCR03EZPF 10 k	B	43.1/23.9
R11	7030011710	S.RES MCR03EZPD 1.8 k	B	42.3/21.8
R20	7030002030	S.RES MCR03EZJH 100 (101)	B	46/23.7
R21	7030000010	S.RES MCR10EZJH JPW (000)	B	36.7/22.8
R27	7030002200	S.RES MCR03EZJH 2.2 k	B	20/14.4
R28	7030000020	S.RES MCR10EZJH 1 (010)	B	21.7/21.2
R31	7030002240	S.RES MCR03EZJH 4.7 k	B	22.1/11.1
R33	7030011190	S.RES ERA3YEB 103V (10 k)	B	49.6/25.5
R34	7030002280	S.RES MCR03EZJH 10 k	B	42.8/28.9
R35	7030000500	S.RES MCR10EZJH 10 k	B	47.2/28.2
R38	7030000380	S.RES MCR10EZJH 1 k	B	47.2/30.5
R44	7030003970	S.RES MCR18EZJH JPW	B	51.3/30.6
R46	7030000010	S.RES MCR10EZJH JPW (000)	B	28.6/25.6

[MAIN UNIT]

REF NO.	ORDER NO.	DESCRIPTION	M.	H/V LOCATION
C1	4030019190	S.CER	B	12.4/3.1
C2	4510005240	ELE 16 ME 22 SWB	B	28.7/13.1
C3	4030019190	S.CER	B	49.6/28.8
C5	4510005240	ELE 16 ME 22 SWB	B	33.9/32.1
C6	4030019200	S.CER	B	35.2/32.1
C7	4030019190	S.CER	B	30.7/26.4
C8	4030019210	S.CER	B	
C9	4030001100	S.CER GRM216B11H102KA01D	B	
J1	6510024940	CNR HEC2305-016250		
DS1	5040002740	LED RT3-03HRYG <ROD>		
S1	2230001190	SW SPPB512300		

M.=Mounted side (T: Mounted on the Top side, B: Mounted on the Bottom side)
S.=Surface mount

• VOLTAGE DIAGRAM

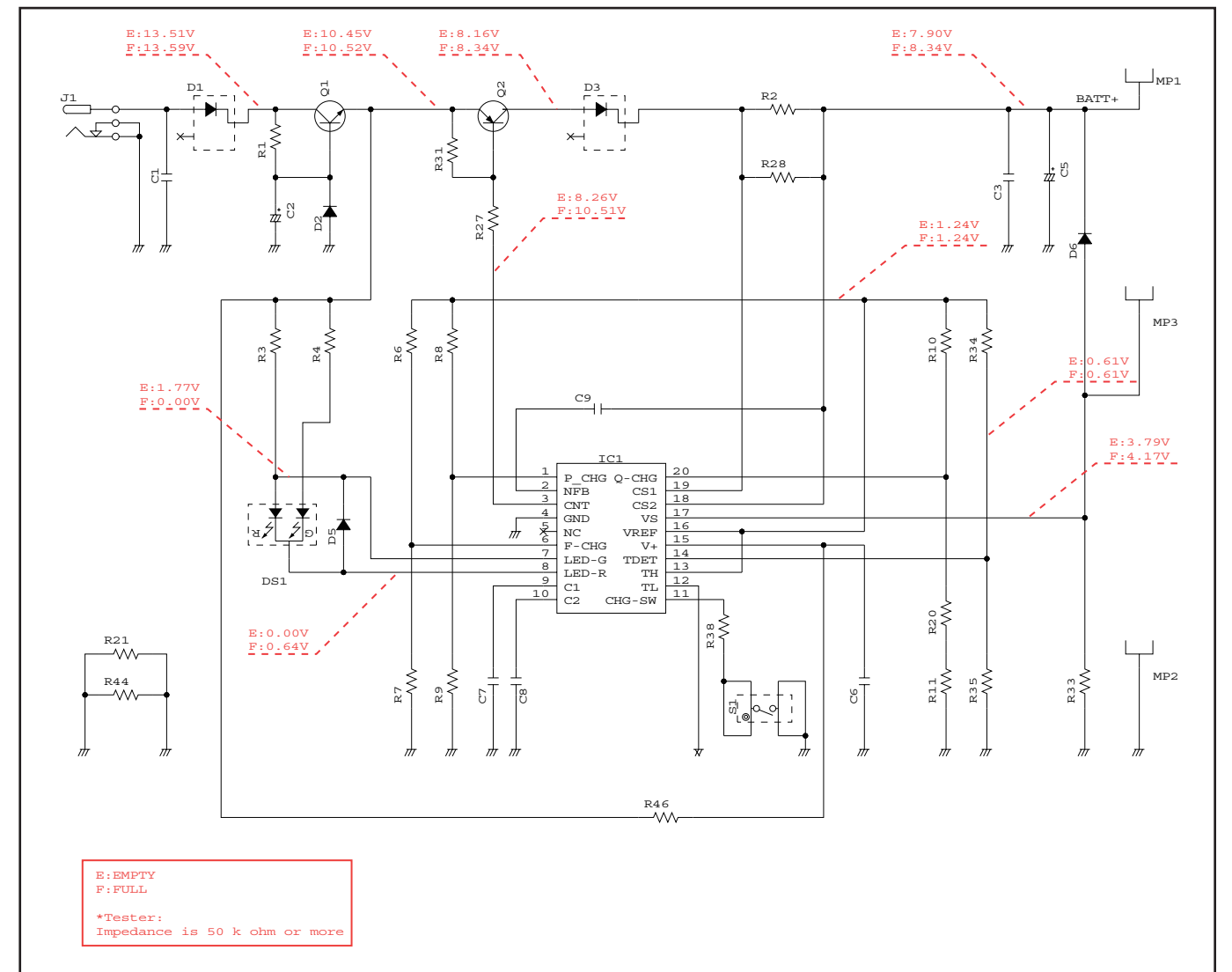

Icom Inc.

1-1-32, Kamiminami, Hirano-ku, Osaka 547-0003, Japan
Phone : +81 (06) 6793 5302
Fax : +81 (06) 6793 0013
URL : <http://www.icom.co.jp/world/index.html>

Icom America Inc.

<Corporate Headquarters>
2380 116th Avenue N.E., Bellevue, WA 98004, U.S.A.
Phone : +1 (425) 454-8155 Fax : +1 (425) 454-1509
URL : <http://www.icomamerica.com>
E-mail : sales@icomamerica.com
<Customer Service>
Phone : +1 (425) 454-7619

Icom Canada

Glenwood Centre #150-6165
Highway 17 Delta, B.C., V4K 5B8, Canada
Phone : +1 (604) 952-4266 Fax : +1 (604) 952-0090
URL : <http://www.icomcanada.com>
E-mail : info@icomcanada.com

Icom (Australia) Pty. Ltd.

Unit 1 / 103 Garden Road, Clayton VIC 3168 Australia
Phone : +61 (03) 9549-7500 Fax : +61 (03) 9549-7505
URL : <http://www.icom.net.au>
E-mail : sales@icom.net.au

Icom New Zealand

146A Harris Road, East Tamaki,
Auckland, New Zealand
Phone : +64 (09) 274 4062 Fax : +64 (09) 274 4708
URL : <http://www.icom.co.nz>
E-mail : inquiries@icom.co.nz

Beijing Icom Ltd.

Room C01, 10th Floor, Long Silver Mansion, No. 88,
Yong Ding Road, Haidian District, Beijing, 100039, China
Phone : +86 (010) 5889 4250 Fax : +86 (010) 5889 4250
URL : <http://www.bjicom.com>
E-mail : bjicom@bjicom.com

Icom (Europe) GmbH

Communication Equipment
Himmelgeister Str. 100, D-40225 Düsseldorf, Germany
Phone : +49 (0211) 346047 Fax : +49 (0211) 333639
URL : <http://www.icomeurope.com>
E-mail : info@icomeurope.com

Icom Spain S.L

Ctra. Rubi, 88, 08190, Sant Cugat del Valles, Barcelona, SPAIN
Phone : +34 (93) 590 26 70 Fax : +34 (93) 589 04 46
URL : <http://www.icomspain.com>
E-mail : icom@icomspain.com

Icom (UK) Ltd.

Unit 9, Sea St., Herne Bay, Kent, CT6 8LD, U.K.
Phone : +44 (01227) 741741 Fax : +44 (01227) 741742
URL : <http://www.icomuk.co.uk>
E-mail : info@icomuk.co.uk

Icom France s.a.s.

Zac de la Plaine
1 Rue Brindejone des Moulinais BP 5804
31505 Toulouse Cedex, France
Phone : +33 (5) 61 36 03 03 Fax : +33 (5) 61 36 03 00
URL : <http://www.icom-france.com>
E-mail : icom@icom-france.com

Asia Icom Inc.

6F No.68, Sec. 1 Cheng-Teh Road, Taipei, Taiwan, R.O.C.
Phone : +886 (02) 2559 1899 Fax : +886 (02) 2559 1874
URL : <http://www.asia-icom.com>
E-mail : sales@asia-icom.com

Icom Polska

Sopot, 3 Maja 54 Poland
Phone : +48 (58) 550 7135 Fax : +48 (58) 551 0484
E-mail : icompolska@icompolska.com.pl

Count on us!

Icom Inc.

1-1-32, Kamiminami, Hirano-ku, Osaka 547-0003, Japan

S-14320XZ-C1
© 2007 Icom Inc.