

31ft sailing cruisers by

WESTERLY®





Stoop-rigged Longbow at sea.

Aft cockpit models

LONGBOW

DEEP DRAFT
FIN KEEL



BERWICK

SHOAL DRAFT
TWIN KEEL



Accommodation is in two cabins, with large heads and two hanging lockers between. The door of one hanging locker will close off the forward cabin if required.

The forward cabin gives two 6ft berths, and headroom under the fore hatch is 5ft 11ins (1.80m).

The main cabin provides a generous 6ft 4ins (1.93m) of headroom, and each of the bunks is over 6ft (1.83m) long.

L-shaped seating at the cabin table allows six to eat in comfort. Every possible space is used to provide storage. There are generous lockers under all bunks, behind the hinged, cushioned seat backs and lockers with sliding doors are fitted under the side decks.

Choices: Ketch or Sloop rig; Aft or 'midships galley.



Main cabin, looking aft; aft galley.

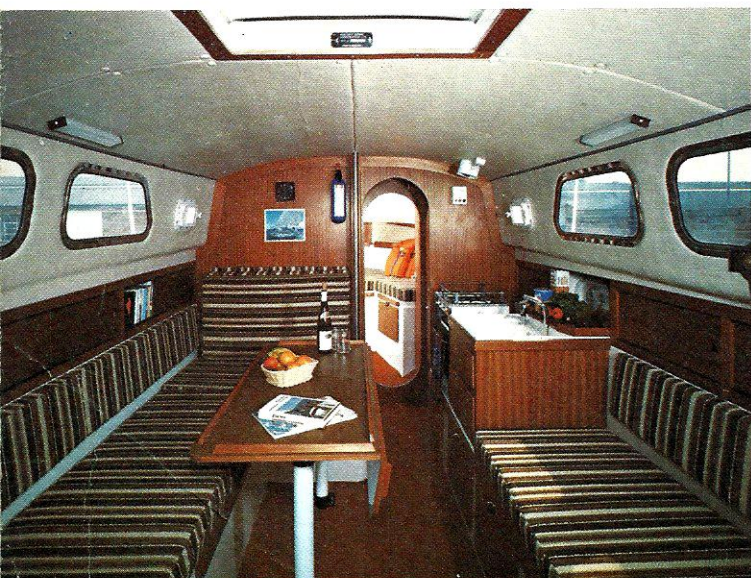

Main cabin, looking for'ard; midships galley.



(Right) Heads and fore-cabin, showing fore-hatch.



Ketch-rigged Pentland at sea.

Aft cabin models

RENOWN

DEEP DRAFT
FIN KEEL



PENTLAND

SHOAL DRAFT
TWIN KEEL



Accommodation is in three cabins. The heads, hanging lockers and forecabin sections are identical on these two versions with those of Longbow and Berwick. The centre cockpit allows for a separate aft cabin, with its own hatch. The fore and main cabins each offer two 6ft (1.83m) + berths and over 6ft headroom.

Two more 6ft + berths are found in the aft cabin behind the cockpit.

As in Longbow and Berwick, there is ample stowage and L-shaped seating. Each boat offers an unusually high degree of family cruising comfort. There is seating for six in the cockpit, and the same number can sit comfortably round the cabin table thanks to the sliding chart table and storage cabinet which runs under the cockpit when not in use.

Choices: Ketch or Sloop rig; Aft or 'midships galley.

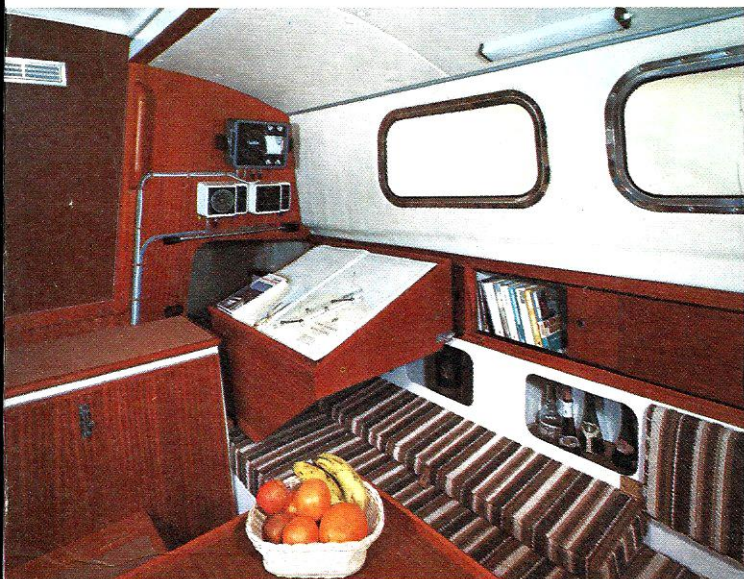

Main cabin, looking aft - Note chart table.

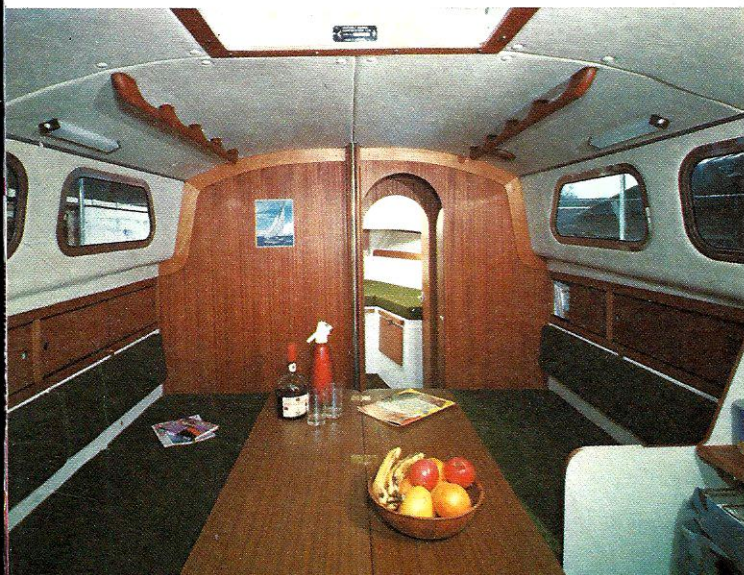

Main cabin, looking forward, aft galley.

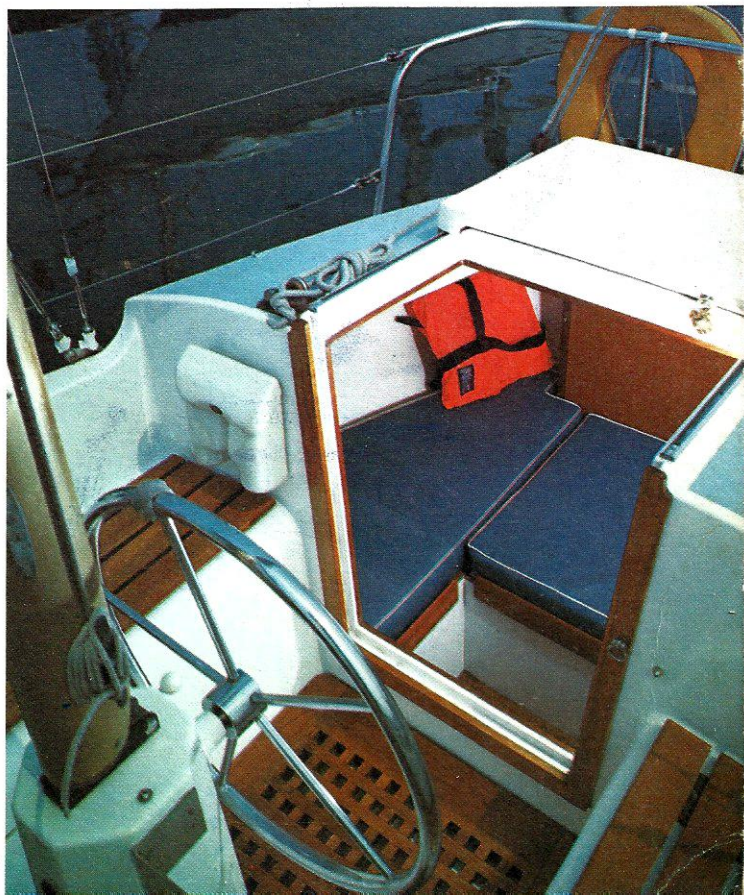

(Right) Aft cabin and hatch for cockpit.

Westerly 31ft Craft

The Westerly 31ft range has been developed to suit the various needs of our many customers. It consists of four versions of one basic hull design, each available with a choice of rigs and interior layouts.

Pentland and Renown have an aft cabin; Berwick and Longbow an aft cockpit.

All are designed by Laurent Giles and Partners as 5/6 - berth off shore sailing cruisers, very seaworthy and capable of making ocean passages. All offer a good standard of comfort for a cruising family, with practical cabins and ample stowage for sailing gear, personal gear and stores, and with uncluttered decks and roomy cockpits. A powerful auxiliary engine is fitted as standard.

The heads are very spacious, and you can choose from a wide range of furnishing materials. Cabin bulkheads and furniture are of wood wherever practical, and there are two insulated ice boxes.

Construction is extremely robust, with heavy reinforcement at key points. Precise, solid workmanship in top-quality materials is a feature of all Westerlys, and fittings are also of first quality throughout. For instance, all deck fittings are through bolted with backing-plates, keels are secured by heavy stainless steel threaded studs; the rudders have stainless steel stocks and stiffening rods; and decks are treated with really effective non-slip paint. Every boat is carefully checked throughout building and is issued with a Lloyd's Register certificate.

This brochure cannot do more than give a general impression of Westerly 31ft craft. Only a test-sail will enable you to evaluate them properly, and any of our sales and service centres will be happy to arrange this. We'll also be glad to show you round our factory at Waterlooville if you're able to visit us.

Optional extras In addition to a very full standard specification, a comprehensive list of extras is available, which includes a spray hood, pressure water system, shower, water heater, double-berth conversions, and 3-cylinder diesel.

Ketch or sloop rig is available on all models. Ketch rig offers somewhat easier handling for very little loss of power or sail area, and can be readily sailed by a husband and wife team.

Aft or 'midships galley Each boat can be fitted with a galley placed centrally to give maximum working space, or aft near the main hatch. Our sales staff will

gladly discuss which would suit your own requirements best. In the meantime, layout diagrams with the brochure show the different arrangements in detail.

After sales service Westerly attach great importance to after-sales service, and endeavour to provide every owner with all the assistance needed with modifications, repairs, advice and sailing instruction if required. This service accounts, to a large extent, for the very high second-hand value of all Westerlys.

Chandlery and spares are available from Westerly's shop at Waterlooville for all your equipment and stores.

The 31ft Westerly Range

Aft Cabin		Aft Cockpit	
PENTLAND Shoal draft	RENOWN Deep draft	BERWICK Shoal draft	Longbow Deep draft
SPECIFICATION			
Draft 3'7" (1.1m)	Draft 4'6" (1.38m)	Draft 3'7" (1.1m)	Draft 4'6" (1.38m)
Weight 10163 lbs 4610 kg	Weight 10080 lbs 4572 kg	Weight 9863 lbs 4474 kg	Weight 9400 lbs 4264 kg
Ballast Weight 4440 lbs 2012 kg	Ballast Weight 4200 lbs 1905 kg	Ballast Weight 4440 lbs 2012 kg	Ballast Weight 4200 lbs 1905 kg
Length overall (sloop)		31' 0"	9.5m
Length overall (ketch)		32' 6"	9.9m inc. bowsprit
Length, waterline		25' 0"	7.62m
Beam		9' 6"	2.9m
Thames measurement		10.35 tons	
Mainsail (ketch)		150 sq. ft.	14.1 sq. m
Mainsail (sloop)		206 sq. ft.	19.2 sq. m
Genoa (ketch)		330 sq. ft.	30.7 sq. m
Genoa (sloop)		333 sq. ft.	31.0 sq. m
No. 1 jib		236 sq. ft.	21.9 sq. m
No. 2 jib		151 sq. ft.	14.0 sq. m
No. 3 jib		61 sq. ft.	5.6 sq. m
Mizzen		54 sq. ft.	5.0 sq. m
Standing rigging		X" (6mm) dia. 1 x 19 stainless steel, swaged ends. (Mizzen 3/8" (4mm) dia 1 x 19.)	
Running rigging		Jib halyard stainless steel, Terylene tail. Main halyard pre-stretched Terylene. Lifts and sheets Terylene.	
Masts and spars		Anodised aluminium alloy.	
Seacocks and skin fittings		Marine bronze.	
Deck fittings		Stainless steel, alloy or coated marine bronze.	
Construction		Each boat carries a Lloyd's Register certificate.	
Designers:		Laurent Giles & Partners	

We are always looking for improvements and thus reserve the right to change the specification without prior notice.

WESTERLY MARINE CONSTRUCTION LTD.,

Aysgarth Road, Waterlooville, Portsmouth, Hants PO7 7UF.
Tel: (07014) 54511 Telex: 86328

Printed in England



WESTERLY 31 FOOT CRAFT

RENOWN

SAIL PLANS

(Not to Scale)

SLOOP

Sail areas — Sloop Rig:

Mainsail	206 sq. ft.	19.2 sq.m.
Genoa	333 sq. ft.	31.0 sq.m.
No:1 jib	236 sq. ft.	21.9 sq.m.
No:2 Jib	151 sq. ft.	14.0 sq.m.
No:3 Jib	61 sq. ft.	5.6 sq.m.

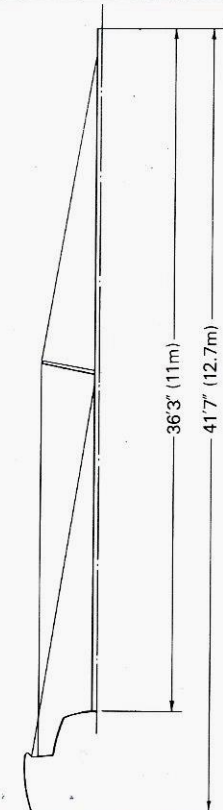
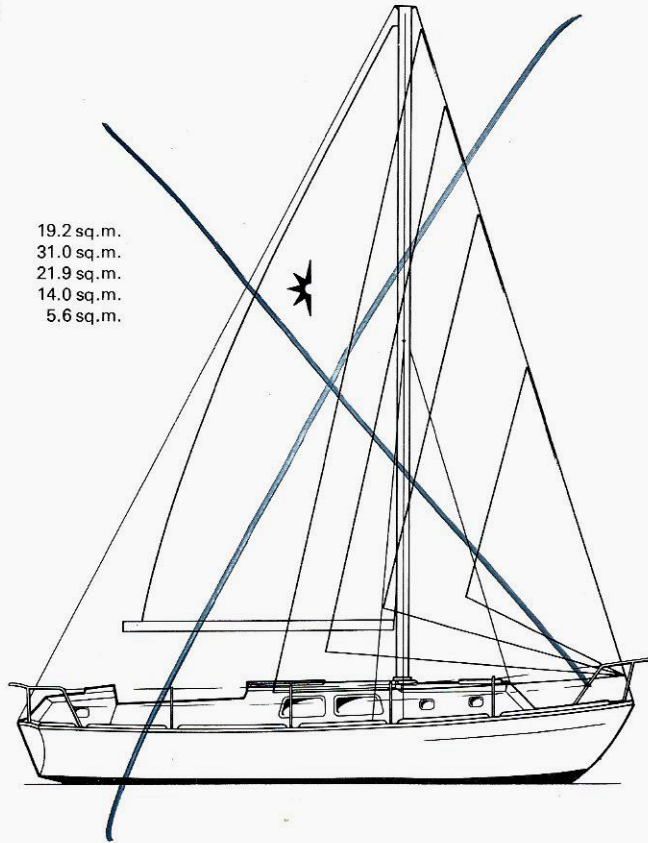

KETCH

Sail areas — Ketch Rig:

Mainsail	150 sq. ft.	14.1 sq.m.
Genoa	330 sq. ft.	30.7 sq.m.
No:1 Jib	236 sq. ft.	21.9 sq.m.
No:2 Jib	151 sq. ft.	14.0 sq.m.
No:3 Jib	61 sq. ft.	5.6 sq.m.
Mizzen	54 sq. ft.	5.0 sq.m.

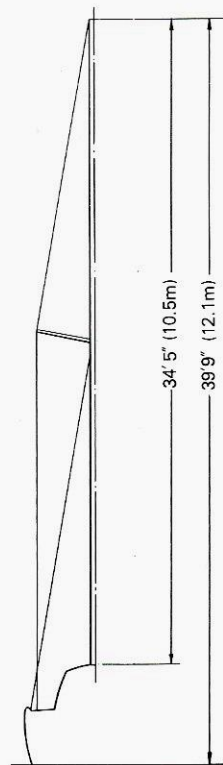
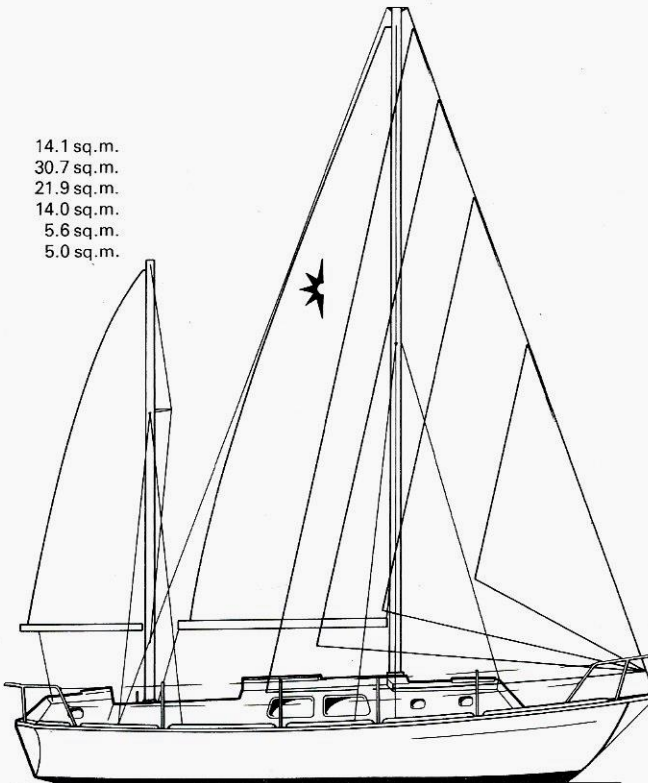

— AFT CABIN MODELS

PENTLAND

INTERIORS

Both have three cabins

MIDSHIPS GALLEY

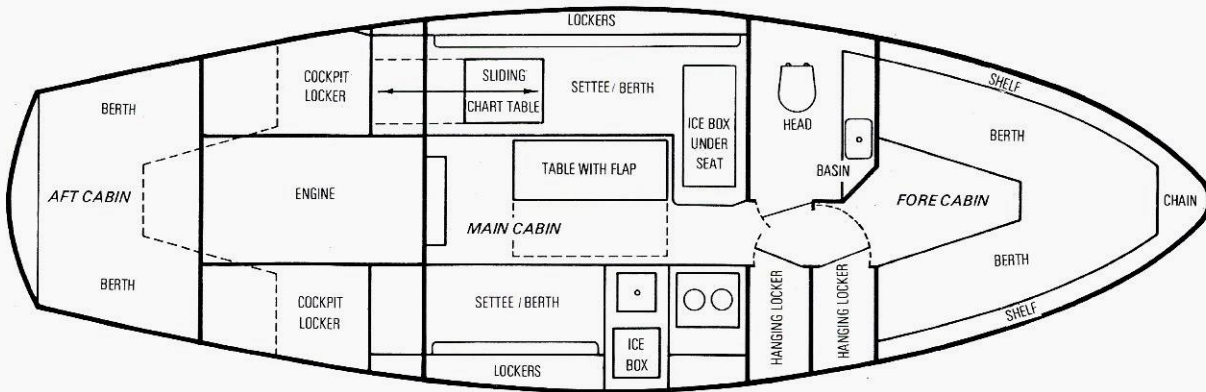

AFT GALLEY

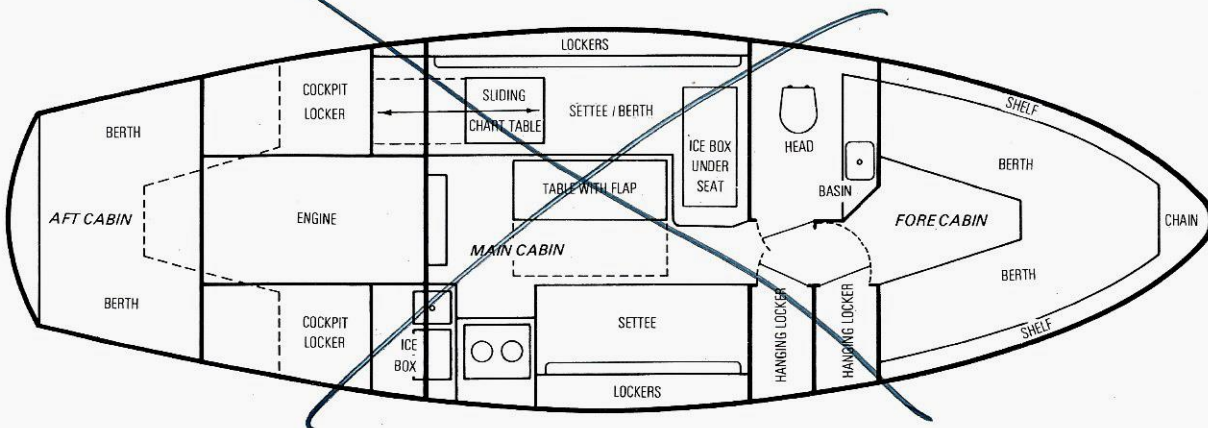

These layouts represent the latest available (1.1.77)



WESTERLY MARINE CONSTRUCTION LIMITED

Aysgarth Road . Waterlooville . Portsmouth PO7 7UF . England

Telephone: Waterlooville 54511. Telex 86328.

WESTERLY 31 FOOT CRAFT **LONGBOW**

SAIL PLANS

(Not to Scale)

SLOOP

Sail areas — Sloop Rig:

Mainsail	206 sq. ft.	19.2 sq.m.
Genoa	333 sq. ft.	31.0 sq.m.
No:1 Jib	236 sq. ft.	21.9 sq.m.
No:2 Jib	151 sq. ft.	14.0 sq.m.
No:3 Jib	61 sq. ft.	5.6 sq.m.

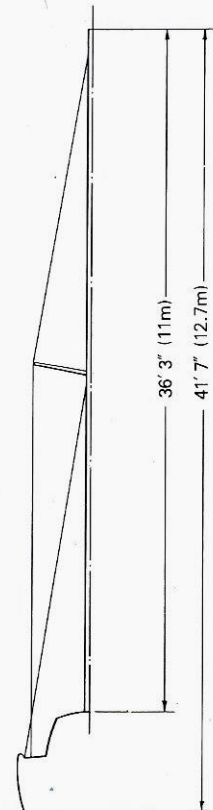
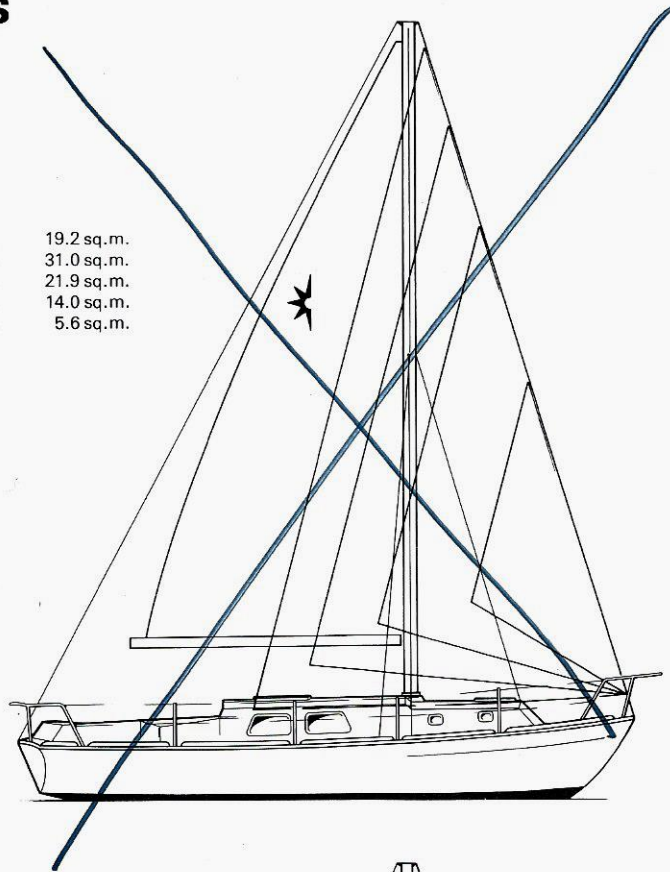

Sail areas — Ketch Rig:

Mainsail	150 sq. ft.	14.1 sq.m.
Genoa	330 sq. ft.	30.7 sq.m.
No:1 Jib	236 sq. ft.	21.9 sq.m.
No:2 Jib	151 sq. ft.	14.0 sq.m.
No:3 Jib	61 sq. ft.	5.6 sq.m.
Mizzen	54 sq. ft.	5.0 sq.m.

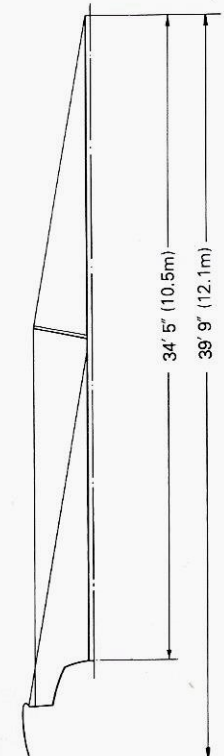
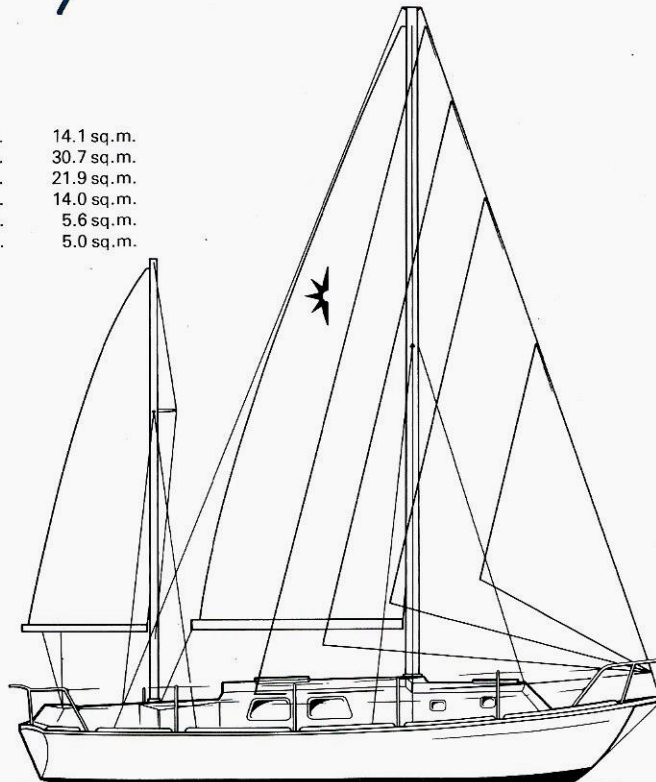

FT — AFT COCKPIT MODELS & **BERWICK**

INTERIORS

Both layouts have two cabins

MIDSHIPS GALLEY

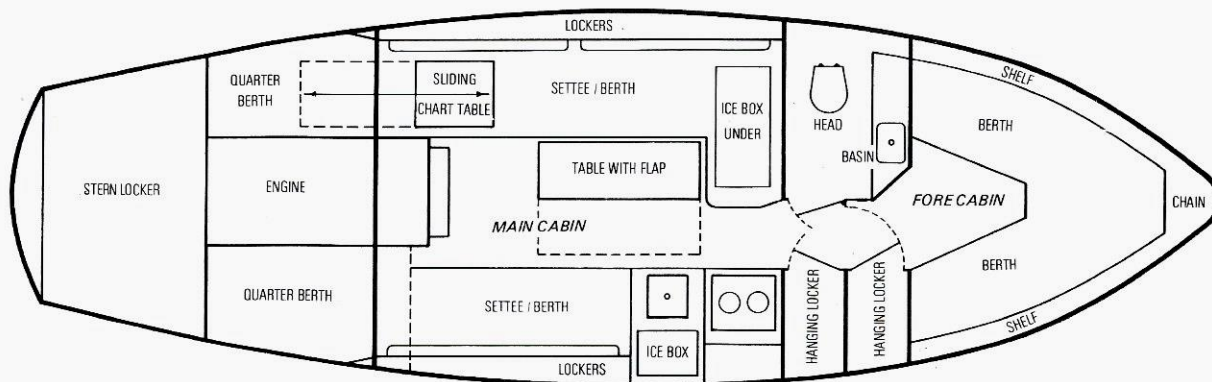

AFT GALLEY

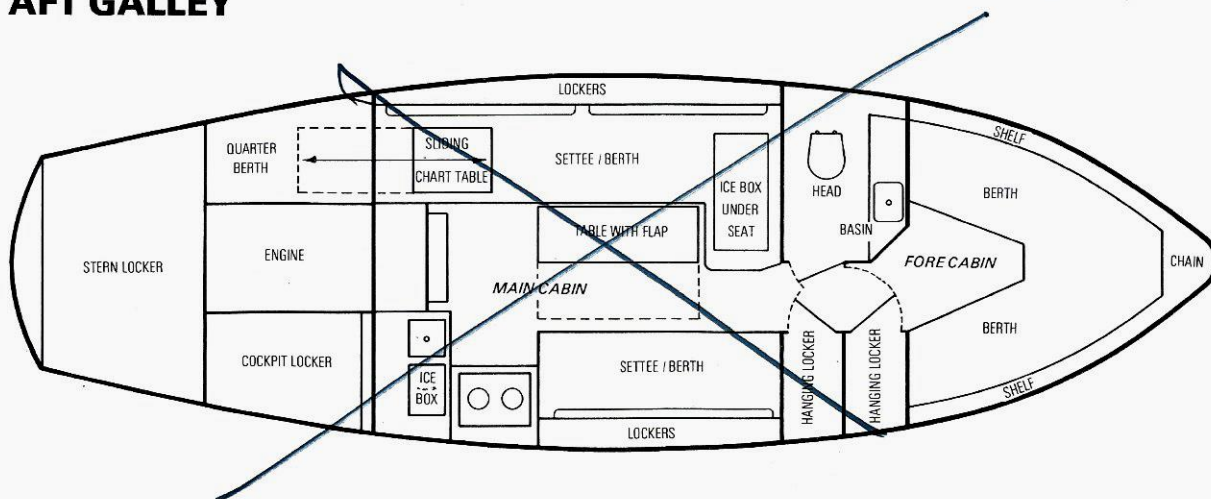

These layouts represent the latest available (1.1.77)



WESTERLY MARINE CONSTRUCTION LIMITED

Aysgarth Road . Waterlooville . Portsmouth PO7 7UF . England

Telephone: Waterlooville 54511. Telex 86328.